

CONTENTS

3 METAL SEALS

5 **Semi metal seals**

18 **Solid metal seals**

31 SOFT MATERIALS SEALS

33 **Graphite gaskets**

36 **PTFE based gaskets**

47 **Fiber based gaskets**

50 **Seals from mica / ceramic / glass fiber**

53 SPECIAL SEALING SYSTEMS

55 **Double Sealing Systems**

56 **Baffle seals**

57 **Plate heat exchangers seals**

58 **Self-energized seals**

61 **Cover plate gaskets**

63 **Valve seals program**

65 GENERAL INFORMATIONS

67 **Common used materials**

70 **Common bars shapes**

72 **Gaskets parameters**

76 **ESA installations procedures**





SPETECH SUCCESSFUL SEALING SYSTEMS

1. METAL SEALS

1.1. SEMI METAL SEALS	5
KAMMPROFILES	5
SPIRAL WOUND GASKETS	9
CONFINATED GASKETS	12
CORRUGATED & JACKETED SEALS	14
1.2. SOLID METAL SEALS	18
RING TYPE JOINTS (RTJ)	18
LENS GASKETS	21
WELD RINGS GASKETS & LIP SEALS	23
SPECIAL SOLID METAL SEALS	27





SPETECH SUCCESSFUL SEALING SYSTEMS

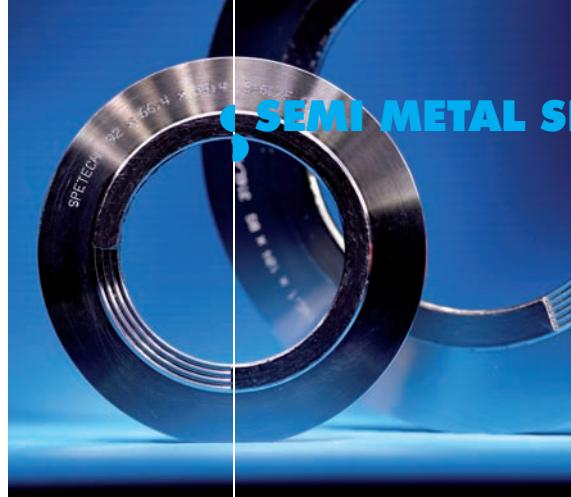

SEMI METAL SEALS

KAMMPROFILES

Service parameters

T (°C)	-200 ÷ +750	500*
P _{max} (bar)	420	100*
Q _{max} (MPa)	600	200*

Widely used in:

Power industry, chemical, petrochemical; high-pressure or high-temperature fixtures, dangerous substances, high external load, inflammable and toxic substances, etc. Those gaskets have become a basic solution in process installations especially within the last ten years. Their growing popularity results from increased tightness and reliability requirements.

Custom styles:

- with non-standard groove depth and profile
- with different gasket's sealing area (styles with centring rings) according to norm EN-1514
- in PTFE or silver jackets for chemical applications
- with locating lugs for easy installation
- concentrically joined with spiral wound gasket
- with different kinds of bars, e.g. MPL® 23, MWK® 10, MPL® 10, MPL® 12
- other than round shapes, e.g. rectangular
- other materials on request

General informations

Availability:

- DIN2697, EN-1514-4, EN 1514-6
- EN-12560-4, EN 12560-6, ASME 16.5, ASME 16.20

Ordering:

- for gaskets obeying EN 1514-4, EN 1514-6, DIN 2697, please indicate the symbol, material, full thickness (of the core and the caps), DN, PN, the standard number, e.g. SPETOMET® MWK® 60 316L/Sigraflex® APX, 4 mm, DN 50 PN 40, EN 1514-6
- for gaskets obeying EN 12560-4, EN 12560-6 please indicate the symbol, thickness, DN, CLASS, the standard number, e.g. SPETOMET® MWK® 60 316L/PTFE, 4 mm, DN 50 CLASS 150, EN 12560-6
- please provide the dimensions or a drawing of non standard gaskets, and possible specific requirements, e.g. "for oxygen"

If full data is not provided, standard gaskets will be produced:

- default standard: EN 1514-6 (DN and PN):
EN 12560-6 (DN/NPS and CLASS)
- default thickness: 4 mm (3+2x0.5)
- default material of the core/caps: 316L/FG-C

Materials available

For wide range of materials available please look into "Common Used Materials" table.

* – please contact SPETECH if the specified values are higher

SEMI METAL SEALS

KAMMPROFILES SPETOMET® MWK®

Designation	Sketch	Description
<p>SPETOMET® MWK® 10</p> <p>SPETOMET® MWK® 10 Z</p>		<p>SPETOMET® MWK® 10 is a conventional kammprofile gasket with the grooves of the same depth; the gasket is applied first of all in tongue and groove flanges, less frequently in male and female flanges; recommended width of the MWK® 10 gasket should not exceed 15 mm due to uneven radial distribution of contact stresses; maximum outer diameter of the gasket – 5000 mm. The SPETOMET® MWK® 10 Z with a loose centering ring, due to increased safety requirements, this type is recommended instead of traditional MWK® 20 type.</p>
<p>SPETOMET® MWK® 15**</p>		<p>SPETOMET® MWK® 15 is a gasket recommended for wide flange faces (for the width >20mm); the grooves of the gasket have different depth which results in the even radial distribution of contact stresses and protect it from being overloaded on the outer circumference of the gasket.</p>
<p>SPETOMET® MWK® 18</p>		<p>SPETOMET® MWK® 18 is a gasket used in the same applications as styles SPETOMET® MWK® 10 and MWK® 20. Different depths of the grooves result in the built up of the contact stress in the middle of the gasket's width which increases its blowout resistance and sealability.</p>
<p>SPETOMET® MWK® 20</p>		<p>SPETOMET® MWK® 20 has the sealing element exactly the same as that of MWK® 10, with additional outer centering ring; integral centering ring of thickness 2 or 3 mm, manufactured in traditional technology; at present in order to meet the increased safety standards this style is replaced by MWK® 21; MWK® 22 is the style for similar applications but with the special centering ring.</p>

** – patented



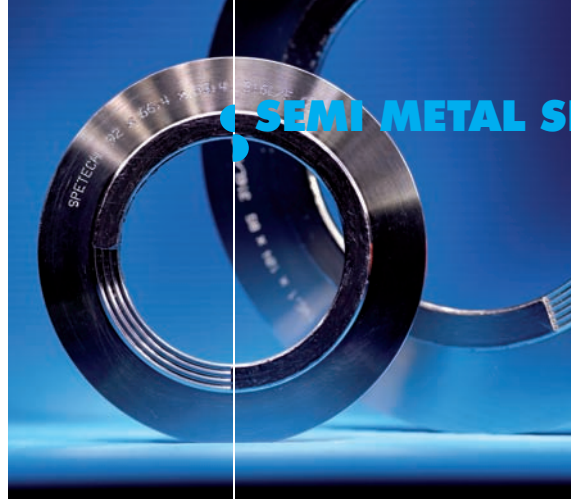

SEMI METAL SEALS

KAMMPROFILES SPETOMET® MWK®

Designation	Sketch	Description
SPETOMET® MWK® 21		SPETOMET® MWK® 21 gasket with the centering ring that has a pre-determined breaking groove – when the joint fails and the medium escapes abruptly from the system the vibrations of the gasket occur – in these circumstances the gasket “breaks” on the groove and centering rings falls out.
SPETOMET® MWK® 25**		SPETOMET® MWK® 25 has the same profile as MWK® 15 but with the centering ring; the ring has a pre-determined breaking groove which increases its blowout resistance.
SPETOMET® MWK® 28		SPETOMET® MWK® 28 has the same profile as MWK® 18; its centering ring has a pre-determined breaking groove increasing gasket’s blowout resistance.
SPETOMET® MWK® 50**		SPETOMET® MWK® 50 gasket has an original profile engineered at SPETECH®, the features distinguishing it from other sealing solutions are better recovery, so called metal core shape flexibility effect due to the proportions between the groove depth and width, improved conformability although the gasket has smaller thickness; this last feature allows for the installation of MWK® 50 even in the shallow grooves where usually soft gaskets are applied.
SPETOMET® MWK® 50 Z		

** – patented

SEMI METAL SEALS

KAMMPROFILES SPETOMET® MWK®

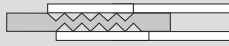
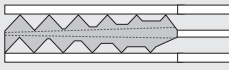
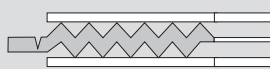
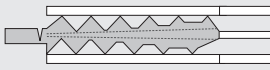
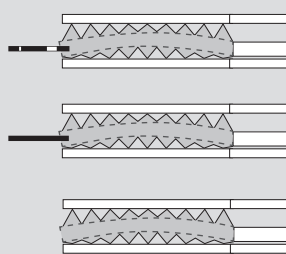
Designation	Sketch	Description
SPETOMET® MWK® 50 B**		SPETOMET® MWK® 50 B for round boiler inspection holes, original design engineered at SPETECH®, the profile allows for relatively deeper grooves and thus thicker sealing layers can be used, it results in good tightness characteristics even in the worn flanges with substantial surface imperfections, the gasket can be inserted into the boiler's opening. Also available customized profile MWK® 10 B with the metal core grooved in traditional way.
SPETOMET® MWK® 55**		SPETOMET® MWK® 55 is an original gasket developed at SPETECH®; it features increased recovery and better conformability, at the same time it reduces the differences of contact stress in radial direction, which prevents the edge of the gaskets from excessive loads; gaskets recommended for wide flanges (for the width >20mm).
SPETOMET® MWK® 60**		SPETOMET® MWK® 60 gasket has the same sealing element as SPETOMET® MWK® 50 but a centring ring with pre-determined breaking groove is added to improved blowout resistance.
SPETOMET® MWK® 65**		SPETOMET® MWK® 65 gasket has the same sealing element as SPETOMET® MWK® 55 but a centring ring with pre-determined breaking groove is added to improve blowout resistance.
DryFlex®** DryFlex® LR DryFlex® NR		Third generation of a komprofile gasket! Three-factor flexibility effect: super flexible sealing element; flexible sealing element assembly in the centring ring and use flexibility – one gasket for one DN diameter, regardless of the PN marking. The DryFlex® gasket was designed as a high quality industrial gasket, combining the advantages of soft-material gaskets and metal gaskets, to be used in industrial pipelines and in machines and heat exchangers.

** – patented



SEMI METAL SEALS

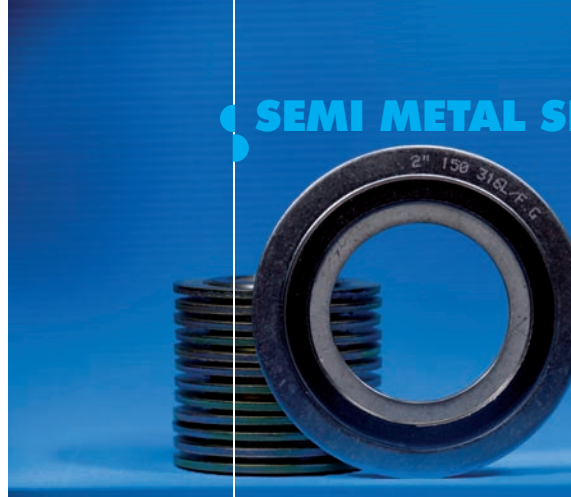

SPIRAL WOUND GASKETS

Service parameters

T (°C)	-200 ÷ +750	450*
P _{max} (bar)	420	100*
Q _{max} (MPa)	300	110*

Widely used in:

Traditional gaskets widely used in refinery, petrochemical, chemical industry, often used in power industry, gas industry, fixture construction; high blowing, thermal, fire resistance; an economical alternative to other high quality gaskets. SPETECH manufactures highest quality gaskets allowing for using small surface pressure and an economical alternative (SPETOSPIR® standard) for big series.

Custom styles:

- gaskets of shape other than round, e.g. oval, elliptical
- gaskets with partition bars e.g. MPL® 23, MPL® 10, GUS® 32
- gaskets with locating lugs
- gaskets with low minimum contact stresses
- gaskets for steam applications, with the inner ring from austenitic steel and metal windings from Hastelloy
- gaskets replacing RTJ style, designed as SZ-RJ
- gaskets in fire-safe constructions with PTFE filler
- gaskets of thickness over 4,5 mm where the metal windings are of W cross section
- special construction: with centring ring for two pressure classes

General informations

Availability:

- for flanges ASME/ANSI B 16.5, class 150 to 2500 LBS, NPS 1" to 24" according to norm ASME B 16.20 (API 601)
- for flanges ASME B 16.47 series A (MSS SP-44), 150 to 900 LBS, 26" to 60" according to norm ASME B 16.20 (API 601)
- for flanges ASME B 16.47 series B (API 605), class 150 to 900 LBS, NPS 26" to 60" according to ASME B 16.20 (API 601)
- for DIN or EN flanges according to DIN 2699 or EN 1514-2
- for flanges according to ISO 7005
- SPETECH standard for ASME flanges
- other national standards

Ordering:

- for gaskets obeying EN 1514-2, DIN 2699, ISO 7483, please indicate the symbol, material, DN, PN, the standard number, e.g. SPETOSPIR® SWZ 316L/316L/PTFE/316L, DN 50 PN 40, EN 1514-2
- for gaskets obeying EN 12560-2, please indicate the symbol, material, DN, CLASS, the standard number, e.g. SPETOSPIR® SWZ 316L/316L/PTFE/CRS, DN 50 CLASS 150, EN 12560-2
- for gaskets obeying ASME B 16.20 please indicate the symbol, material, NPS, CLASS, the standard number, e.g. SPETOSPIR® SZ, 304/PTFE.CRS, NPS 2" CLASS 150, ASME 16.20
- please provide the dimensions or a drawing of non-standard gaskets, or any special requirements, e.g. "for oxygen"

If full data is not provided, standard gaskets will be produced:

- default standard: EN 1514-2 (DN and PN); EN 12560-2/ASME B 16.20 (DN/ NPS and CLASS)
- default type: SPETOSPIR® SWZ
- default thickness: SPETOSPIR® SWZ and SZ: 4.5/3 mm
 SPETOSPIR® SW 3.2/2 mm up to DN 600 (NPS 24")
 4.5/3 mm from DN 700 (NPS 26")
 SPETOSPIR® S 3.2 mm up to DN 600 NPS 24")
 4.5 mm up from DN 700 (NPS 26")
- default material: SPETOSPIR® SWZ: 316L/316L/FG-C/CRS**
 SPETOSPIR® SZ: 316L/FG-C/CRS
 SPETOSPIR® SW: 316L/316L/FG-C
 SPETOSPIR® S: 316L/FG-C

Materials available

For wide range of materials available please look into "Common Used Materials" table.

* – please contact SPETECH if the specified values are higher

SEMI METAL SEALS

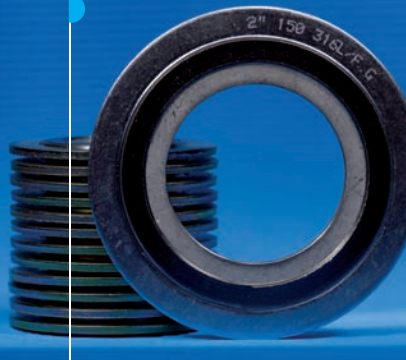

SPIRAL WOUND GASKETS SPETOSPIR®

Designation	Sketch	Description
SPETOSPIR® S		SPETOSPIR® S – spiral wound gasket made from alternate layers of metal strip and filler; reinforced only by the metal piles welded together, wound around the soft filler. S style is applied in male and female, tongue and groove flange, also in the joints with so called multi-channel load transmission.
SPETOSPIR® SW		SPETOSPIR® SW gasket with inner ring providing additional strength, made from the same metal as the strips; besides giving strength, the ring fills the space between flange bore and the inside diameter, minimizes erosion of flange faces; applied in male and female flanges, even in very high pressures.
SPETOSPIR® SZ		SPETOSPIR® SZ gasket with outer centring ring, facilitating proper installation of the gasket; outer ring also protects gasket from blowout and provides the space for coding the gaskets with digits, letters and colour, which inform about the gasket's style, materials and manufacturer; in some constructions used as a compression stop. Gasket engineered for flat and raised face flanges; for applications in flanges above PN 40 (class 300) and when the filler is PTFE, SWZ style is recommended. As standard, centring ring is made from carbon steel, painted or galvanized.
SPETOSPIR® SWZ		SPETOSPIR® SWZ gasket has two metal rings: outer (centring) and inner – reinforcing; due to „enclosing” the proper sealing element between the to rigid metal rings, the gasket has excellent compression resistance; the style recommended for flat face and raised face flanges over PN 40 (class 300), for gaskets with PTFE filler also of lower PN; for gaskets of large dimensions (above 800 mm) suggested as standard. The standard inner ring is made from the same material as gasket's metal strip in the sealing area.



SEMI METAL SEALS

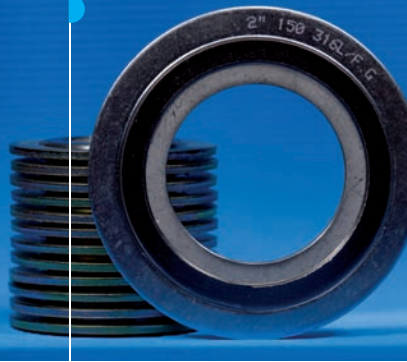

SPIRAL WOUND GASKETS SPETOSPIR®

Designation	Sketch	Description
SPETOSPIR® SWZ LS Low Stress		SPETOSPIR® SWZ gasket might be produced as Low Stress (LS) style gasket. Style LS, provides all the superior sealing properties of a spiral wound gasket for the applications where only the low-stress forming pressure is available.
SPETOSPIR® SnWZ		SPETOSPIR® SnWZ gasket with inner ring made from metal thinner than that applied in the sealing area; it may result from the necessity of providing the gasket with very narrow ring e.g. when the active width of the gasket is optimized, or due to accessibility of non-standard alloys for the rings.
SPETOSPIR® SWZD		SPETOSPIR® SWZD gasket is a two zones gasket applied as antioxidation style for gaskets working in temperatures above 500°C – in the zone exposed to medium graphite, outside – mica, or as firesafe style of the PTFE filled spiral wound gasket, in such a case inner filler – PTFE, outer filler – graphite
SPETOSPIR® SWZT		Triple-zone SPETOSPIR® SWZT special gasket for strongly oxidizing media with graphite at middle zone, mica at inside and outside.
SPETOMET® MWK® 50 / SPETOSPIR® SWZ		SPETOSPIR® MWK® 50/SPETOSPIR® SWZ double gasket provide additional sealability performance, especially under variable conditions; usually for heating or cooling shell pipelines.

SEMI METAL SEALS

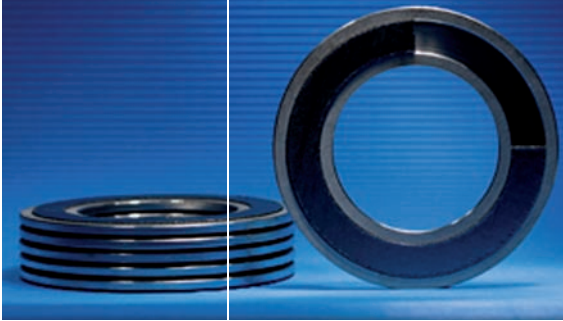

CONFINATED GASKETS

Service parameters

T (°C)	-200 ÷ +750	500*
P _{max} (bar)	420	100*
Q _{max} (MPa)	500	200*

Widely used in:

The SPETOGRAPH® GUS® 600 gaskets and its variations are used as especially resistant for squeezing, blowing, vibration, preserving high forming capacity; they are adjusted both for standard flanges connections, as well as for device connections possessing special construction features. This resolves the most difficult tightness problems in industrial installations.

Custom styles:

- full face with bolt holes
- gaskets with bars and of shapes other than round
- SPETOGRAPH® GUS® 660 styles with graphite sealing element in the form of gaskets with metal eyelets, e.g. SPETOGRAPH® GUS® 660/32, GUS® 660/42, etc.
- sensors, e.g. temperature, can be fitted in SPETOGRAPH® GUS® 660

General informations

Ordering:

- for SPETOGRAPH® GUS® 600 series gaskets please indicate nominal dimensions of the collar and the rabbets, e.g. SPETOGRAPH® GUS® 660 Z for the DN 300 PN 100 flanges obeying EN 1092-1, rabbet B2

Standard dimensions:

- the SPETOGRAPH® GUS® 660, GUS® 660 Z gaskets are produced according to the plant's dimension standards concerning the flanges obeying ISO 7005, ASME 16.5, ASME 16.47, EN 1092 etc.

Materials available

For wide range of materials available please look into "Common Used Materials" table.

* – please contact SPETECH if the specified values are higher



SEMI METAL SEALS

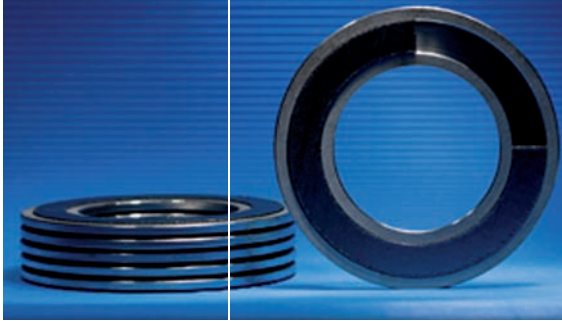

CONFINATED GASKETS SPETOGRAPH® SERIES 600

Designation	Sketch	Description
<p>SPETOGRAPH® GUS® 660</p> <p>SPETOGRAPH® GUS® 660 Z</p>		<p>SPETOGRAPH® GUS® 600 gaskets are recommended for extremely difficult applications, with very high loads both static and dynamic, as well as for old, damaged flange faces or where limited bolt stress is the case. These may be flanges adjacent to pumps, compressors, gate valves etc. self-compensating pipelines, floating heads, inspection holes; application of properly selected layers eliminates necessity of reconditioning of flange faces and ensures very good elastic recovery as well as compensation of bolt relaxation; gasket is resistant to external loads, blowout and has constant axial dimension (important for machine construction); has very good tightness. Main applications of SPETOGRAPH® GUS® 660 gaskets are large heat exchangers, vessels found in chemical industry sealing the floating head and vessel's bottom, valves in petrochemical industry, refineries and power plants, pipelines in power engineering installations. SPETOGRAPH® GUS® 660 gaskets are individually selected for specific applications by SPETECH engineers.</p>
<p>SPETOGRAPH® GUS® 670 I</p>		<p>SPETOGRAPH® GUS® 670 I gaskets are applied in very narrow flange faces in tongue and groove as well as in male and female flanges; properties similar to those of SPETOGRAPH® GUS® 660.</p>

CORRUGATED & JACKETED SEALS

Service parameters

T (°C)	-200 ÷ +750	500*
P _{max} (bar)	200	40*
Q _{max} (MPa)	300	120*

Widely used in:

Gaskets commonly applied in refineries, chemical and petrochemical industry, applied also in gas production and distribution and in pharmaceutical industry (MPL® 12 style); applied in flange joints in valve systems, apparatus and pipelines; the gasket features ability to compensate for alignment imperfections, gaskets in metal jackets (styles MPL® 20÷MPL® 29 Z) traditionally have been applied in petrochemical industry. Manufactured from such metals as soft iron, stainless steel 304 and 316 L, brass and others; graphite, ceramic and other non asbestos materials are used as fillers.

Custom styles:

- metal jacketed gasket with additional PTFE or graphite sealing layers
- gaskets with bars from soft material (e.g. GUS® 32, GUS® 42)
- MPL® 12 T gasket with inner eyelet from PTFE instead of steel for enamelled flanges
- gaskets in other material options

General informations

Availability:

- DIN 7603
- ASTM 16.47
- ASTM 16.5
- EN 1514-7
- EN 12560-7

Ordering:



- for gaskets obeying EN 1514-7, please indicate the symbol, thickness, material, DN, PN, the standard number, e.g. SPETOMET® MPL 23 Z, 3 mm, 316L/PTFE, DN 150 PN 40, EN 1514-7
- for gaskets obeying EN 12560-7, please indicate the symbol, thickness, material, DN, CLASS, the standard number, e.g. SPETOMET® MPL 23 Z, 3 mm, 316L/graphite, DN 50 CLASS 150, EN 12560-7
- please provide dimensions or a drawing for non-standard gasket

Materials available



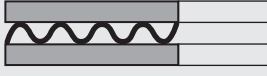
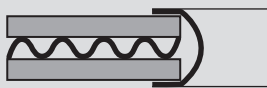

For wide range of materials available please look into "Common Used Materials" table.

* – please contact SPETECH if the specified values are higher

CORRUGATED & JACKETED SEALS SPETOMET® MPL®

Designation	Sketch	Description
SPETOMET® MPL® 10		The SPETOMET® MPL® 10 gaskets are made of a metal core and thin layers on; it is used as a basic type of gaskets for narrow flange surfaces or as a bar of multiedge or spiral wound gaskets. MPL® 10 metal only style is also available.
SPETOMET® MPL® 11		SPETOMET® MPL® 11 gasket from corrugated metal face, used for less severe temperatures where flanges are lightly loaded; corrugation increases conformability of the gasket; gasket can be galvanized; in rare cases it is applied in this construction, most frequently it is a metal core of SPETOMET® MPL® 12 style.
SPETOMET® MPL® 12		SPETOMET® MPL® 12 gasket is manufactured from corrugated steel rings covered on both sides with soft sealing material, e.g. graphite or expanded PTFE, corrugation increases conformability of the gasket whereas layers improve the tightness of the sealed joint - also with the ceramic layers for the furnace covers and dust pipelines; applied in tongue and groove, male and female flanges, for flat flanges also as MPL® 12 Z style.
SPETOMET® MPL® 121		SPETOMET® MPL 121 compared to MPL® 12 features better sealability, blowout resistance and physiological safety; metal eyelet mostly from 1.4571 stainless steel; available also MPL® 121 Z style with optimized width of the gasket's sealing area.

CORRUGATED & JACKETED SEALS SPETOMET® MPL®

Designation	Sketch	Description
SPETOMET® MPL® 20		SPETOMET® MPL® 20 flat gasket in single metal jacket with an opening is used for narrow flanges; manufactured from metal sheet, which encapsulates soft filler; such profile protects the soft edge of the gasket's material; most of gaskets of this style are made from copper and its width is less than 6 mm; for larger cross sections MPL® 23 style is recommended.
SPETOMET® MPL® 21		SPETOMET® MPL® 21 gasket is similar to MPL® 20 but the metal jacket is overlapped and closes the soft filler; maximum width of the gasket is also 6 mm.
SPETOMET® MPL® 23		SPETOMET® MPL® 23 are double jacketed gaskets made from two pieces of metal and soft filler. This gasket is the most commonly used profile for heat exchangers and other vessels: the two piece metal construction gives extra rigidity which allows for large diameters; may be manufactured in various shapes and dimensions; also the profile with centring ring MPL® 23 Z.
SPETOMET® MPL® 23 I		SPETOMET® MPL® 23 I gasket has additional metal part inside the filler stabilizing the profile (prevents excessive, transverse deformation of the gasket); the metal inside increases gasket's strength, by improving its resistance to stress; thickness above 3,2 mm is recommended for this profile in order to apply the metal part; this is a proper solution also for the gaskets with the desired end thickness.

SEMI METAL SEALS

CORRUGATED & JACKETED SEALS SPETOMET® MPL®

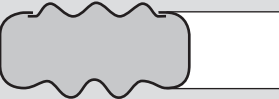
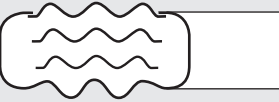
Designation	Sketch	Description
SPETOMET® MPL® 24		SPETOMET® MPL® 24 compared to MPL® 23 style has features increased resistance characteristics, recommended for gasket thickness over 3,2 mm and in case of flat flanges or male and female flanges; for flat flanges also the style MPL® 24 Z with the centring ring is available.
SPETOMET® MPL® 26		SPETOMET® MPL® 26 gasket in the corrugated metal jacket; it has better conformability due to reduced contact area (corrugations), recommended for gasket's width over 13 mm.
SPETOMET® MPL® 29		SPETOMET® MPL® 29 is the gasket composed of corrugated jacket and the metal corrugated filler; better temperature resistance, maximum temperature depending only on the metal properties; used also in applications where due to chemical attack soft filler cannot be applied; features also high resistance to compression.

One piece construction

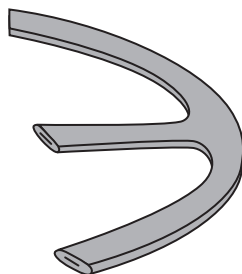

Welded construction

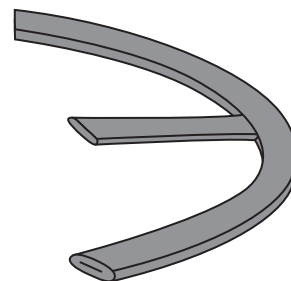

SOLID METAL SEALS



RING TYPE JOINTS (RTJ)

Service parameters

T (°C)	-200 ÷ +750	550*
P _{max} (bar)	1500	350*
Q _{max} (MPa)	650	400*

General informations

Description:

SPETORING® gaskets are applied at extreme temperatures and pressure loads in refineries, power plants, petrochemical industry, oil drilling, pipelines, valves and pressure vessels, RTJ-R, RTJ-OR, RTJ-BX, RTJ-RX gaskets need special flange arrangement for the installation; SPETORING® RTJ are applied in pressures up to 20.000 psi.

Ring joint gaskets (RTJ) are metallic solid sealing solution for high pressure / temperature applications and are fitted in special ring groove type flanges. They are blowing-out resistant and very reliable solution.

RTJ gaskets are widely used in pressure vessels like valves, pipelines in the Petrochemical and Oil&Gas industry.

Material selection can be determined dependent on fluid temperature and flange hardness. They comply with EN 12560-5, ASME B16.20 standard and API spec 6A. The gaskets are turned to the required dimensions/tolerances and surface finish using CNC high quality technology. Carbon steel and soft iron RTJ gaskets can be zinc plated in accordance with API specifications.

Any other non-standard styles and workmanship are possible. All type of EN 10204 certificates on request.

Materials available

For wide range of materials available please look into "Common Used Materials" table.

* – please contact SPETECH if the specified values are higher



SPETECH SUCCESSFUL SEALING SYSTEMS

18

ООО «ТИ-СИСТЕМС» ИНЖИНИРИНГ И ПОСТАВКА ТЕХНОЛОГИЧЕСКОГО ОБОРУДОВАНИЯ

Интернет: www.tisys.ru www.tisys.kz www.tisys.by www.tesec.ru www.ти-системс.рф

Телефоны: +7 (495) 7774788, 7489626, (925) 5007155, 54, 65 Эл. почта: info@tisys.ru info@tisys.kz info@tisys.by

SOLID METAL SEALS



RING TYPE JOINTS (RTJ) SPETORING® RTJ

Designation	Sketch	Description
SPETORING® RTJ OCTAGONAL		SPETORING® RTJ (octagonal) gaskets have been widely used mainly in oil and gas industry; they are manufactured from steel (special alloys on request) and installed in special flange arrangement; at present only trapezoidal arrangement is applied for octagonal RTJ-R gaskets; RTJ-R gaskets have total blowout resistance, its design provides two sealing barriers, therefore they do not fail in very dangerous installations; in special styles available also as a plug, with centring ring, galvanized; manufactured almost exclusively in dimension standards according to NPS 36, non standard up to 3000 mm.
SPETORING® RTJ OVAL		SPETORING® RTJ (oval) gasket is manufactured from steel or special alloys, available in the same dimensions as octagonal gasket; may be applied also in very old, semi-round grooves in flanges; gasket is blowout resistant, has two sealing barriers; due to the contact area between semi-round surface of the gasket and the flange face the stress is built up which helps improve tightness; applied in installations containing dangerous medium; in special styles available as the plug with centring ring or galvanized; manufactured almost always in dimension standards according to NPS 36, non standard up to 3000 mm.

SOLID METAL SEALS



RING TYPE JOINTS (RTJ) SPETORING® RTJ

Designation	Sketch	Description
SPETORING® RTJ-RX		SPETORING® RTJ-RX gasket is a modified version of RTJ-R which has higher active internal pressure resulting in increased contact stress; RTJ-RX gaskets are manufactured from various sealing materials; in special constructions with galvanic coating.
SPETORING® RTJ-BX		SPETORING® RTJ-BX gaskets are engineered for the highest pressure ratings up to 20.000 psi; it is a solution requiring special facing arrangement; blowout resistant, opening in the axial direction has the function of balancing the pressure loads in the situation when the inner sealing barrier is not tight; the gasket manufactured only in dimension standards to NPS 30.
SPETORING® RTJ-BLIND		Beside the standard RTJ seals we provide RTJ oval or octagonal, RX and BX profiles as blind rings. Shape of the rings is similar to seals which they replace, but commonly they are equipped with a plate which facilitate installation for maintenance service and also enable to include any necessary information of basic data of the connection.

SOLID METAL SEALS

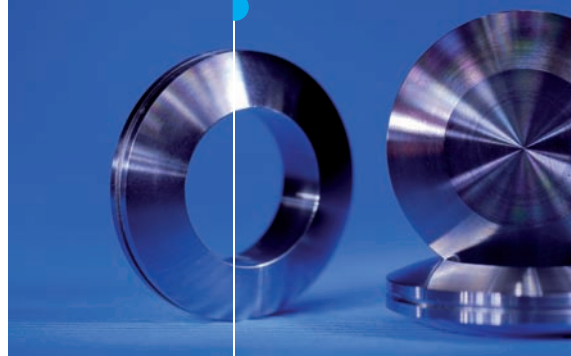

LENS GASKETS

Service parameters

T (°C)	-200 ÷ +750	550*
P _{max} (bar)	420	320*
Q _{max} (MPa)	650	400*

General informations

Description:

Lens Gaskets took the name from lens shape that they have. Thanks to spherical contact area of the gasket with the conical flange arrangement the high value local stress is accumulated and very good tightness is achieved. Special shape of the lens gaskets and being produced from solid metal makes that lens gaskets are resistant to contact stress overpressure. Another key advantage of Lens Gasket is that these seals are practically totally resistant to blowout, although, unlike RTJ gaskets, they have only one sealing barrier. All the lens style seals request special spherical shape of flanges.

Materials available

For wide range of materials available please look into "Common Used Materials" table.



* – please contact SPETECH if the specified values are higher

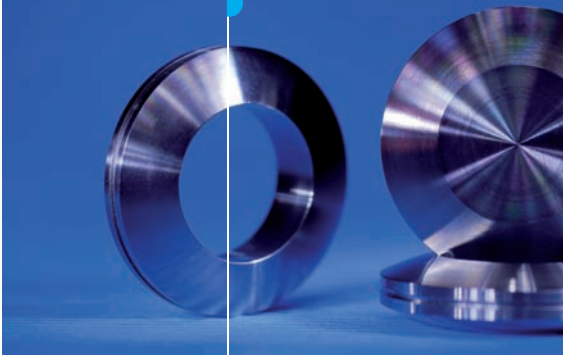

SOLID METAL SEALS

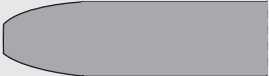

LENS GASKETS SPETORING® LENS

Designation	Sketch	Description
SPETORING® LENS 2696		Most popular Lens Gasket being nowadays installed are manufactured to well known standard DIN 2696 which describes Lens Gaskets from DN 10 PN 63 up to DN300 PN 400.
SPETORING® LENS SPECIAL STANDARD		Beside DIN 2696 standard there are many like 'Company Specifications' (or 'National Standards' or 'Branch Standards') which describe in details particular shapes and details of lens forecasted especially to any Company (or Country or Branch). All these particular construction are covered by Spetech production program.
		Another two ideas meet widely in lens gaskets area are: galvanization of lens seals (which mainly aims are to improve tightness of the connection and/ or decrease roughness (smoothness) of the flange contacting areas and providing blind or spectacle-type blind lens seals (used for special purposes like emergency, maintenance or any other).
SPETORING® LENS BLIND		Lens Gaskets described above which are manufactured to many different standards are in practice forecasted to various standard pipeline connections. Spetech is manufacturing also customized lens gaskets with maximum size of 3000mm. Such special constructions are producing acc. to special customers specifications, drawings, and other data.



SOLID METAL SEALS

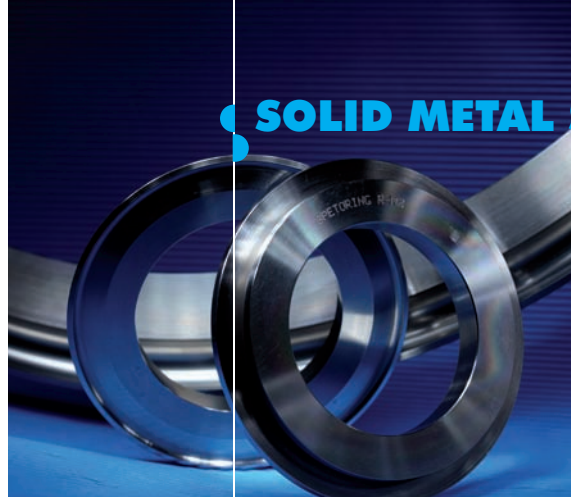

WELD RINGS GASKETS & LIP SEALS

Service parameters

T (°C)	-200 ÷ +750	550*
P _{max} (bar)	1500	500*
Q _{max} (MPa)	650	400*

General informations

Description:

The SPETORING RM Weld Ring Seals are suitable for applications where it is absolutely necessary to have a leak proof joint and also where a limited opportunity for disassembling is required (which effects long time period between scheduled revisions). Special reasons for Weld Ring requirement may also be: containment of hazardous medium and combination of difficult working conditions (temperature shocks, vibrations, axial or lateral flange movements, etc.).

The main equipment where these seals are applied are pressure vessels (heat exchangers, thermal reactors, chemical apparatus, etc). Other group of applications are pipelines which, however, request less sophisticated Weld Rings constructions normally.

Starting from 2010 all the Spetech Weld Rings with 'seal to flange' seam weld from outside are possible to be installed for application with bars (partitions). This fact should make the Weld Rings Seals even more popular solution for 'trouble making' joints.

SPETECH Weld Ring seals are manufactured to fit to EN, ASME, DIN, GOST, JIS, WN, OST or any other standards flanges. Commonly they are individually designed according to customer constructions and specifications.

SPETECH is supplying Weld Ring seals in diameter up to 6000mm. "One piece" seamless construction of the rings should be available for most of requests. Gasket materials are generally recommended to be the same or similar to the pipe or flange materials but all the times the Specification settlement is the priority.

The most popular materials for SPETORING RM including Nickel based alloys, Vessel steel grades, Stainless Steel and many others are shown in 'Common Used Materials' table. Any other material on request.

Materials available

For wide range of materials available please look into "Common Used Materials" table.

* – please contact SPETECH if the specified values are higher



SOLID METAL SEALS

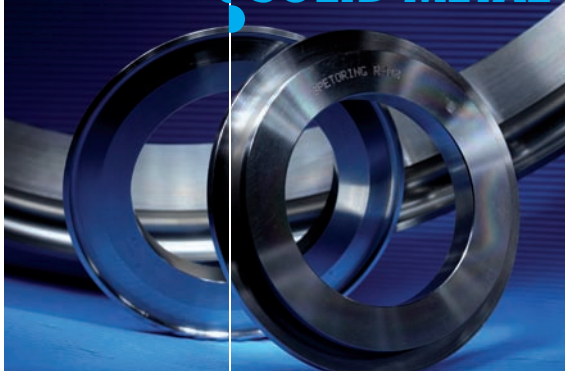

WELD RINGS GASKETS & LIP SEALS SPETORING® R-M

Designation	Sketch	Description
SPETORING® R-M 1		<p>SPETORING® R-M 1 is a basic solution for application where the space between flanges is limited. Widely met as per DIN 2695 standard 4mm thick rings. Easiest solution either concerning material consumption and manufacturing cost.</p> <p>Inside weld seams are the only available option (errors on inside joint welding are difficult to repair). Any customised dimensions also available. Rewelding: can be re-welded up to 5 times, material loss ~3mm each. Radial compensation up to 0.3mm.</p>
SPETORING® R-M 2		<p>This solution is technically based on idea similar to what is in RM-1 case but both outside weld seams/ inside weld seams option is available which facilitate installation.</p> <p>Customised construction of SPETORING® R-M 2 are available – starting from this profile all profiles with outside weld seam can be deliver with partitions. Rewelding up to 5times (3mm each loss). Please not the radial compensation is only like 0.1mm.</p>
SPETORING® R-M 3		<p>First of hollow lip weld-ring seals solution. It performs more thermal and pressure shock resistance compare to RM-1 and RM-2. But the 'membrane' effect is yet not that visible as the hollow lip small dimensions. Customize cross-sections and partitions available.</p> <p>Outside weld seams available but as all this construction is strongly determined by existing limitations (not enough space between flanges for RM-5 and existing radial movements of the joint deserving the hollow-lip solution) the access to outside seam is difficult, which effect request of high performance in welding process.</p> <p>The SPETORING® R-M 3 is Weld Ring Seal is possible to be installed for application with bars (partitions). However re-welding is possible approx. 2-3times. Radial compensation up to 0.5mm.</p>



SOLID METAL SEALS

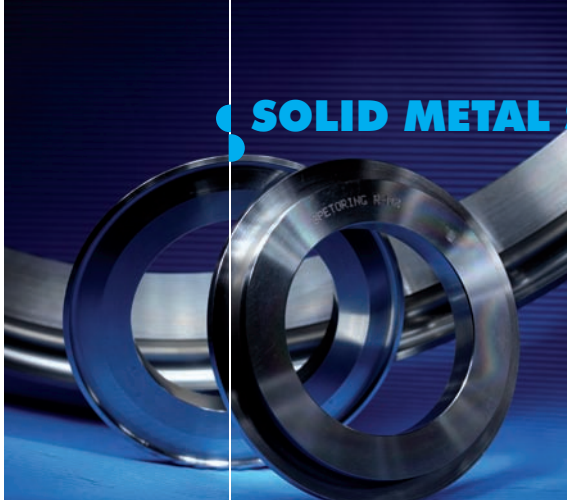

WELD RINGS GASKETS & LIP SEALS SPETORING® R-M

Designation	Sketch	Description
SPETORING® R-M 4		<p>Full size hollow lip weld-ring gasket (inside weld seam only available to flanges). Advanced construction recommended especially for large diameter joints. SPETORING® R-M 4 is capable to compensate great axial and radial differential expansions; extremely resistant to thermal and pressure shocks.</p> <p>The inside weld seam sometimes is a great advantage as prevent from crevice corrosion in compare to outside seam solution. If crevice corrosion is an important issue – than auxiliary inside seal should also be used.</p> <p>Typical thickness is 2x15mm (30mm for full seal). Customised cross-section and diameters are available (which allows to install this adopted/ customized weld ring seal using existing flanges with shapes ready for other types of seals: spigot recess, delta shape, double cone, etc...).</p> <p>Rewelding up to 4times (easy to dismantle with 2mm cut-off disc). Radial compensation up to 5.0mm.</p>
SPETORING® R-M 5		<p>Full size hollow lip weld-ring gasket (outside weld seam possible). Most advanced construction recommended especially for large flanges and joints equipped in any partitions requested !</p> <p>Capable to compensate great an axial and radial differential expansions; extremely resistant to thermal and pressure shocks.</p> <p>In SPETORING® R-M 5 customised cross-section and diameters are available (which allows to install this adopted/ customized weld ring seal using existing flanges with shapes ready for other types of seals: spigot recess, delta shape, double cone, etc...). This Weld Ring Seal is possible to be installed for application with bars (partitions).</p> <p>Rewelding up to 4times (easy to dismantle with 2mm cut-off disc) can be re-welded 2 to 4 times.</p> <p>Radial compensation up to 5.0mm.</p>

SOLID METAL SEALS

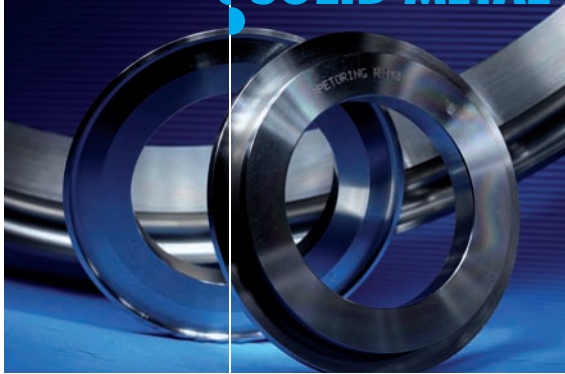

WELD RINGS GASKETS & LIP SEALS SPETORING® R-M

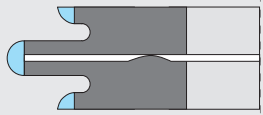
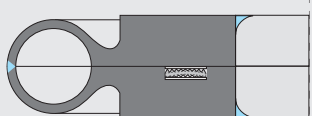
Designation	Sketch	Description
SPETORING® R-M 2 / CONVEX		<p>Auxiliary weld-ring gasket in different styles: – installed either in groove closed from 4sides (Dryflex, Convex, Kammprofile, Spiral Wound, o-ring); – installed in groove closed from 3sides (Dryflex, Convex, Kammprofile, o-ring); – sealing profile (Dryflex, Convex, Kammprofile) machined on the weld ring surface.</p> <p>The following function of auxiliary gasket: – preventing crevice corrosion (inside weld seam solutions case); – hydraulic pressure test performed using this spare gasket, than final welding or repeat dismantling option; – auxiliary gasket is used as reliable primary operational seal and the weld ring additional prevention seal if the primary one will fail.</p>
SPETORING® R-M 4 / DRYFLEX		

SOLID METAL SEALS

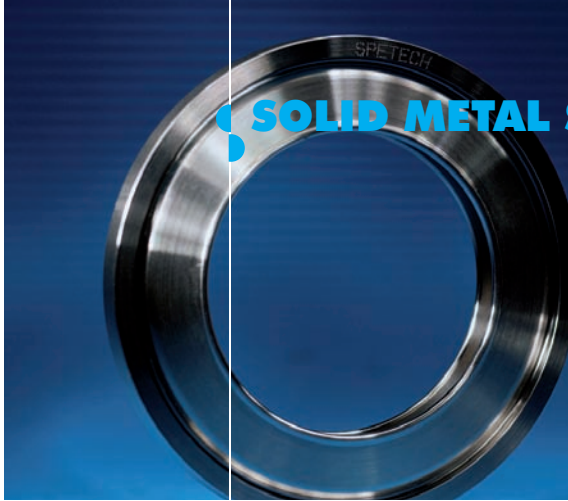

SPECIAL SOLID METAL SEALS

Designation	Sketch	Description
<p>SPETORING® R-B Convex Gasket</p>		<p>SPETORING® R-B convex style seals different than others seals described in this section are widely installed in the standard flanges. Due to the metal – metal contact between the convex surface of the gasket and the flange face the tightness of the joint is very high, gasket is resistance to blowout, chemical attack and fire-safe. Additionally convex gasket geometry in the same moment ensures very long service life time and protects flange face from being damaged. The rule is that the SPETORING® R-B convex gaskets should be produced from material softer than flange faces and in the in special cases you can use galvanic coating or layers (silver, aluminium) to achieve this. Convex seals are manufactured in accordance with many dimension standards beside popular international (ASME, EN, JIS, GOST, etc most popular are DIN 7603 form D for union fittings and DIN 837 for pressure gauges and associated valves).</p>
<p>SPETOACTIV® R-K Self energized metal seal</p>		<p>This special self energized metal seal is the only existing self energized metal seal that request no groove in the flange. It is a combination of self energized v-ring with centering ring which works also as supporting (anti collapsing) ring. Thanks to the SPETOACTIV® R-K supporting ring this seal might be used on flat flanges with no need to have time and efforts taking groove machining operation, which should make Self-Energized Seals an optional solution for most of trouble making applications.</p>



SOLID METAL SEALS

SPECIAL SOLID METAL SEALS

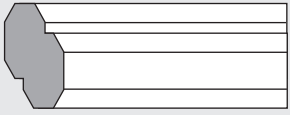
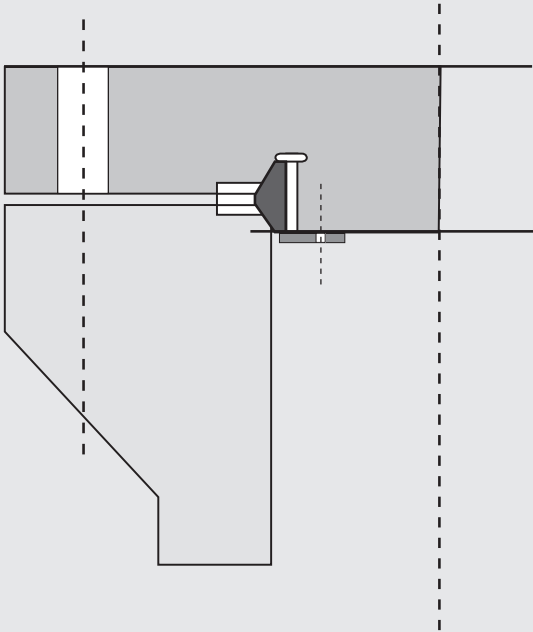
Designation	Sketch	Description
<p>SPETORING® RTJ Transition rings</p>		<p>SPETORING® RTJ transition rings are used for sealing ring type joints in which the flanges have different ring groove diameters or even for jointing two flanges being totally different style (flange with groove with flat flange style).</p>
<p>SPETORING® R-S Double Cone Seal</p>		<p>SPETORING® R-S Double Cone Seals are provided commonly to highest duty pressure vessels equipment (mostly in chemical processing industry). Typical working pressure 50-350 bars and typical temperature up to 400°C, diameter between 500 to 3000mm. They are self-energized gasket which construction details need to be designed essentially by the device designers. Although they look similar to octagonal RTJ the rule of sealing effect of the joint is different than RTJ.</p> <p>How it works? After being acted by internal pressure, double cone seal expands outward and the contact pressure between gasket and flange increases substantially. Normally at the conical surfaces of the SPETORING® R-S Double Cone Seal layers of soft metal are installed – mostly silver, soft iron, aluminium or copper with thickness of 0,5÷1mm. To increase friction conical surfaces of gasket (which contact with flange surfaces) are often additionally machined: either with 2-5 grooves (0,5÷1mm deep) or given convex shape.</p> <p>Please note that during fitting the radial gap of 0,05mm for every 100mm of diameter of non-assembled seal should be precisely controlled and at the cylindrical, supporting surface of cover should be machined longitudinal grooves; Hence internal pressure act on the cylindrical internal surface of the gasket.</p>





SOLID METAL SEALS

SPECIAL SOLID METAL SEALS

Designation	Sketch	Description
<p>SPETORING® R-D Delta Seal</p>		<p>SPETORING® R-D Delta Seal is used for pressure vessel covers. It requires a special flange construction with triangular grooves. How it works? The total depth of grooves is a little bit lower than the height of gasket in the non-installed state. When tighten up the bolts, the cover gently approaches to the shell flange. After starting the pressure the delta seal bends cross section and contacts linearly in bottoms of groove under high contact pressure. As being acted by internal pressure the delta seal bends even more outwards, and the conical surface of seal tightly contacts the conical surfaces on seal grooves. Please note the high machining accuracy and high precision of any surfaces of SPETORING® R-D Delta style joints are required!</p> <p>Also the edges of the delta seal can imprint bottoms of grooves, so - after disassembling - machining of grooves and - probably - new gasket with new (increased) height will be required.</p> <p>Application range of delta seal is up to 2000mm of diameter temperature mostly lower than 400°C and pressure lower than 400 bars.</p>
<p>SPETORING® R-W Bredtschneider Seal (wedge seal)</p>		<p>Bredtschneider Seal is another solution used to secure tightness in to self - tightening covers. The construction of seat for this kind of seal is very special and need perfect geometry of conical contact surface both: at cover and shell. For positioning and blocking of gasket special segment ring is needed.</p> <p>The pretightening force of bolt (must be strain bolts in cover and in segmented ring) is very low. The sealing action is coming from internal pressure acting on cover. This working (medium) pressure is multiplied into contact pressure of SPETORING® R-W in two ways:</p> <ol style="list-style-type: none"> 1. because surface of cover is many times smaller than contact surface, 2. because wedge geometry of seal multiply axial force into radial contact force. <p>Normally Bredtschneider Seal is manufactured from the material softer than cover and flange material (after installation seal ring is closed almost "hydraulically" from all sides). Please note disadvantage can be observed, when material of ring is too soft and extrude in gaps between cover and shell. In can cause the disassembly difficulties.</p> <p>Good sealing properties can be kept even when the temperature and pressure fluctuate. The typical application range for Bredtschneider Seal are: pressure to 400 bars, temperature 350°C and diameter 1300 mm.</p> <p>In praxis geometry of this kind of seals can vary: cross section may be symmetrical or not and face surface can be perpendicular to axe of shell or not.</p>

For wide range of materials available please look into "Common Used Materials" table.



SOFT MATERIALS SEALS

2.1. GRAPHITE GASKETS	33
2.2. PTFE BASED SEALS	36
2.3. FIBER BASED GASKETS	47
2.4. SEALS FROM MICA / CERAMIC / GLASS FIBERS	50





SOFT MATERIALS SEALS



GRAPHITE GASKETS

Service parameters

T (°C)	-200 ÷ +650	450*
P _{max} (bar)	250	40*
Q _{max} (MPa)	270	150*

Widely used in:

SPETOGRAF® gaskets GUS® 30 style and GUS® 40 style are applied in petrochemical industry and refineries, power and heat generation and in all the installations with exposure to high temperature media. Applied in the construction of the pipelines, valves, vessels and heat exchangers; typical working temperatures -200 ÷ +550°C in customized versions up to +650°C

Custom styles:

- full face gaskets with bolt holes
- metal eyelets from other materials, e.g. Hastelloy or silver
- gaskets with bars and of shapes other than round
- gaskets for plastic flanges

Ordering:

- for gaskets obeying EN 1514-1, DIN 2690, DIN 2691, DIN 2692, ISO 7483 please indicate the symbol, thickness, DN, PN, for the EN and ISO standards, please indicate the type (e.g. IBC, FF, TG or SR in case of EN 1514-1), the number of the standard, e.g. SPETOGRAF® GUS® 31, 2 mm, DN 50 PN 40, IBC, EN 1514-1,
- for gaskets obeying EN 12560-1 please indicate the name, thickness, DN, CLASS, type, number of the standard, e.g. SPETOGRAF® GUS® 31, 2 mm, DN 50 CLASS 150, IBC, EN 12560-1,
- for gaskets obeying ASME 16.21 please indicate the name, thickness, NPS, CLASS, the number of the standard, e.g. SPETOGRAF® GUS® 31, 2 mm, NPS 2" CLASS 150, ASME 16.21,
- please indicate the dimensions or a drawing for non standard gaskets, and any special requirements, e.g. "used for oxygen".

General informations

Availability:

- DIN2690, DIN 2691, DIN 2692, ISO 7483, EN 12560-1, EN 1514-1, ASME 16.21, other
- SIGRAFLEX® Universal sheets 1500x1500 or 1000x1000 th.: 1,5; 2;3mm
- SIGRAFLEX® C2A sheets 1500x1500 or 1000x1000 th.: 2;3 mm
- SIGRAFLEX® Hochdruck sheets 1000x1000 or 1500x1500 th.: 1; 1,5; 2;3;4mm

Gaskets

- DIN 2690÷2692, DIN 7168, EN 1514-1, EN 12560-1, ASME B 16.5, B 16.21, B 16.47
- Sheets SIGRAFLEX® Standard 1000x1000 thickness: 1; 1,5; 2mm
- Sheets SIGRAFLEX® Economy 1000x1000 thickness: 1,5; 2; 3mm
- Sheets SIGRAFLEX® Universal 1000x1000 and 1500x1500 thickness: 1,5; 2; 3mm
- Sheets SIGRASEAL® dimensions 1500x1500 thickness: 2; 3mm

In case when the full data is not provided, standard gaskets will be produced:

- default standard EN 1514-1 (DN and PN); EN 12560-1 (DN/NPS and CLASS)
- default normative dimension type IBC
- default thickness: 2 mm up to DN 400 (NPS 16")
3 mm from DN 450 (NPS 18")
- default PN/CLASS: PN 10-40 up to DN 80
PN 16 from DN 100
CLASS 150 for all the NPS

* – please contact SPETECH if the specified values are higher

SOFT MATERIALS SEALS



GRAPHITE GASKETS SPETOGRAF® SERIES GUS® 30, GUS® 40

Designation	Sketch	Description
<p>SPETOGRAF® GUS® 30</p> <p>SPETOGRAF® GUS® 30 PRO</p>		<p>The SPETOGRAF® GUS® 30 gaskets are made of SIGRAFLEX® Universal sheet, i.e. of graphite foil, the purity of which is >98%, with an oxidization inhibitor mechanically connected to a perforated stainless steel reinforcement 1.4401; the top layer of the graphite is specially impregnated, which protects the board from humidity, increases its tightness and scratch resistance; optimized technology of the metal carrier perforation prevents the flange surfaces from being scratched; the SPETOGRAF® GUS® 30 PRO gaskets are made of Sigraflex® Universal Pro sheet holding a TA-Luft certificate, the gaskets are available in 1; 1,5; 2; 3 mm thickness, standard advised thickness is 2mm for sizes up to DN 400 and 3 mm for sizes over DN 400.</p>
<p>SPETOGRAF® GUS® 31</p>		<p>The SPETOGRAF® GUS® 31 is a high-quality solution, especially while using inflammable or toxic substances, they are tighter and more blowing resistant, they hold a PZH certificate concerning food, and a IGNIG one for the natural gas.</p>
<p>SPETOGRAF® GUS® 32</p> <p>SPETOGRAF® GUS® 32 Z</p>		<p>The SPETOGRAF® GUS® 32 gaskets are preferred as segment gaskets, assembled by the producer, in which the edges function as a hardening element during transportation (for DN>900); the outer edge may also be used in temperatures over 550°C as an anti-oxidization protection, the GUS® 32 Z may also be used for flat flange surfaces.</p>
<p>SPETOGRAF® GUS® 33</p>		<p>The GUS® 33 are destined for cleaning and review holes.</p>

SOFT MATERIALS SEALS



GRAPHITE GASKETS SPETOGRAF® SERIES GUS® 30, GUS® 40

Designation	Sketch	Description
<p>SPETOGRAF® GUS® 40</p> <p>SPETOGRAF® GUS® 40 PRO</p>		<p>The SPETOGRAF® GUS® 40 gaskets are produced of highest quality graphite sheet SIGRAFLEX® Hochdruck made in form of a multi-layer laminate being the combination of the metal foil (0,05 mm of thickness) and of graphite foil (1.1 g/cm³ of density, nuclear purity, 0,45 mm of thickness) joined in a special non-glue process and impregnated on the surface. The SPETOGRAF® GUS® 40 PRO gaskets are produced of Sigraflex® Hochdruck Pro sheet, holding a TA-Luft certificate. Those gaskets are of extreme resistance, the greatest of all the currently used soft sealing materials; they are used on tonque and groove type, notch-appendage type and flat and raised flange surfaces in any dimension standards; they are typically used under high-pressure water gauge glasses. The SPETOGRAF® GUS® 40 gaskets are frequently used as very narrow, <5 mm wide gaskets.</p>
<p>SPETOGRAF® GUS® 41</p>		<p>The SPETOGRAF® GUS® 41 gaskets are preferably used on flat and raised flange surfaces due to its increased tightness, blowing resistance, erosion resistance and resistance against so-called "intoxication" of the gasket. It is deemed to be high-quality taking into account the above criteria. The SPETOGRAF® GUS® 43 is used in review hatches, cleaning holes, etc.</p>
<p>SPETOGRAF® GUS® 41 I</p> <p>SPETOGRAF® GUS® 41 IZ</p>		<p>The SPETOGRAF® GUS® 41 I, GUS® 41 IZ, with a metal centralizing ring; they allow for optimizing the connection by decreasing the active width of the gaskets and for saving the sheet surface; the steel centralizing element allows also for producing elements which facilitate the assembly.e.g. in case of vertical materials. The types equipped with a metal carrier SPETOGRAF® GUS® 41 I, GUS® 41 IZ are used or in case of high contact pressure or in case of large diameters in order to assure rigidness and breaking resistance of the gaskets; it is used with DN>900 and in special situations in which greater thickness of the gasket is required;</p>
<p>SPETOGRAF® GUS® 42</p>		<p>The SPETOGRAF® GUS® 42 gaskets with an additional outer eylet increasing its rigidness and oxidization resistance.</p>

SOFT MATERIALS SEALS



PTFE BASED SEALS (FILLED PTFE) SPETOFLON® FL

Service parameters

T (°C)	-200 ÷ +260	120*
P _{max} (bar)	200	40*
Q _{max} (MPa)	160	80*

Widely used in:

Chemical industry, petrochemical, food (including production of alcohol), pulp and paper, low and medium pressure pipeline joints, manufacture of vessels and reactors, tanks and containers; SPETOFLON® FL gaskets are designed for contact with chemically aggressive media; also due to absolute physiological inertness; bacteria and fungi do not grow on SPETOFLON® FL material; in comparison with standard PTFE the materials have significantly improved mechanical characteristics, particularly increased resistance to creep and strength.

Custom styles:

- full face gaskets with bolt holes
- gasket other than round
- gaskets with additional sealing strip from ePTFE
- shaped gaskets from PTFE of various cross sections applied in e.g. glass pipelines in the laboratories etc.

General informations

Ordering:

- for gaskets obeying EN 1514-1, DIN 2690, DIN 2692, ISO 7483, please indicate the symbol, thickness, DN PN, the kind in case of EN and ISO standards (e.g. IBC, FF, TG or SR for EN 1514-1), the standard number e.g. SPETOFLON® FL 300, 2 mm, DN 50 PN 40, IBC, EN 1514-1
- for gaskets obeying EN 12560-1, please indicate the symbol, thickness, DN, CLASS, the standard number, e.g. SPETOFLON® FL 300, 2 mm, DN 50 CLASS 150, EN 12560-1
- for gaskets obeying ASME B 16.21 please indicate the symbol, thickness, NPS, CLASS, the standard number, e.g. SPETOFLON® FL 300, 2 mm, NPS 2" CLASS 150, ASME 16.21
- please provide the dimensions or a drawing of non-standard gaskets, or any special requirements, e.g. "for oxygen".

Availability:

Gaskets delivered according to the following norms:

- DIN 2690 ÷ 2692
- ASME B16.5
- ASME B16.21
- ASME B16.47
- ISO 7483
- EN 1514-1
- EN 12560-1

In case when the full data is not provided, standard gaskets will be produced:



- default standard: EN 1514-1 (DN and PN); EN 12560-1 (DN/NPS and CLASS)
- default normative dimension type IBC
- default thickness: 2 mm up to DN 400 (NPS 16")
3 mm from DN 450 (NPS 18")
- default PN/CLASS: PN 10-40 up to DN 80
PN 16 from DN 100
CLASS 150 for all the NPS

* – please contact SPETECH if the specified values are higher

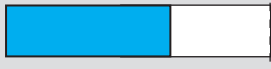

SOFT MATERIALS SEALS

PTFE BASED SEALS (FILLED PTFE) **SPETOFLON® FL**

Designation	Sketch	Description
<p>SPETOFLON® FL 160 F (GLASS FIBER)</p> <p>SPETOFLON® FL 160 S (GLASS MICRO-SPHERES)</p>		<p>SPETOFLON® FL 160 – glass filled PTFE, very economical material, designed for the applications with industrial media except for elemental fluorine, concentrated potassium and sodium hydroxide, ammonia hydroxide, sodium silicate, fluorosilicic acid, chromic acid, hydrogen cyanide, fluorohydrogen acid and in case of very high sealability requirements.</p>
<p>SPETOFLON® FL 200</p>		<p>SPETOFLON® FL 200 is a high quality material of medium compressibility and very good strength and sealability characteristics; applied in vessels and pipelines. SPETOFLON® FL 200 is most frequently applied in installation with hot sodium hydroxide and potassium hydroxide, solutions used for galvanization of chromium, cooling liquids, etc. Specially selected filler with PTFE creates homogenous material which gives gaskets specific mechanical and chemical properties, material hardens in contact with the medium; easy to cut and form.</p>
<p>SPETOFLON® FL 300</p>		<p>Highest quality filled material based on PTFE with special non-organic filler. Highest technically available creeping resistance, high allowable surface pressure, tightness (TA-Luft), penetration resistance even while using most penetrating substances, like monomers; SPETOFLON® FL 300 is distinguished by a wider range of chemical resistance in comparison with PTFE-based materials filled with glass fibre. It is recommended for oleum.</p>

 filled with glass

 filled with barium sulphate

 filled with silica

SOFT MATERIALS SEALS

PTFE BASED SEALS (FILLED PTFE) **SPETOFLON® FL**

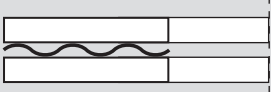
Designation	Sketch	Description
SPETOFLON® FL 160 J		<p>SPETOFLON® FL gasket on the metal corrugated ring is used to improve recovery and conformability (especially in case of imperfections, misalignments and non-parallel flanges) for large dimensions flanges; in this case the material of the corrugated ring must be selected so that it is chemically resistant to the sealed medium.</p>
SPETOFLON® FL 200 J		
SPETOFLON® FL 300 J		
SPETOFLON® FL-TF		<p>SPETOFLON® FL TF - gasket manufactured from virgin, sintered PTFE of 22.10 g/cm³ density, material physiologically harmless and chemically inert (with exception to elemental fluorine and molten alkalis); because of the cold flow, gasket should be selected for the joints with low <math><40\text{N/mm}^2</math> compressive stress and medium service temperatures below 100°C, in tongue and groove flanges.</p>

SOFT MATERIALS SEALS



PTFE BASED SEALS (EXPANDED PTFE) GORE™, SPETOFLON® TEX

Service parameters

T (°C)	-200 ÷ +260	120*
P _{max} (bar)	200	40*
Q _{max} (MPa)	150	100*

Widely used in:

chemical industry, pulp and paper, petrochemical, pharmaceutical, food industry (including production of alcohol), heat and power generation, machine building, vessels, water pipelines, potable water station, technical gases including oxygen, gaskets used in valves, machines, heat exchangers in both power engineering and chemical installations, pipelines, especially made from plastic, glass, rubber coated and other, in reactors, distillation columns, tanks and containers. In all applications where low seating load is required, excellent tightness, high mechanical resistance to relaxation, physiological properties, chemical resistance but at low and medium pressures; Gore™ series 300 tape th. 2, 3 mm is also considered as a universal sealing solution for maintenance personnel.

Custom styles:

- other than round, with bars etc.
- full face gaskets with bolt holes
- gaskets with the core other than corrugated ring
- gaskets with metal inner and outer edging or made from sintered PTFE
- SPETOFLON® TEX FGR sheets in non-standard sizes.
- SPETOFLON® TEX FGR-H gaskets with SPETOFLON® TEX DE layers

General informations

Ordering:

- for gaskets obeying EN 1514-1, DIN 2690, DIN 2691, DIN 2692, ISO 7483 please indicate the symbol, thickness, DN, PN, and for EN and ISO standards, the type (IBC, FF, TG or SR according to EN 1514-1), the standard number, e.g. GORE™ GR, 2 mm, DN 50 PN 40, IBC, EN 1514-1
- for gaskets obeying EN 12560-1, please indicate the symbol, thickness, DN, CLASS, the standard number, e.g. GORE™ GR, 2 mm, DN 50 CLASS 150, IBC, EN 12560-1
- for gaskets obeying ASME B 16.21 please indicate the symbol, thickness, NPS, CLASS, the standard number, e.g. GORE™ GR, 2 mm, NPS 2" CLASS 150, ASME 16.21
- please provide the dimensions or a drawing of non-standard gaskets, or any special requirements, e.g. "for oxygen"

Availability:

Gaskets delivered according to the following norms:

- DIN 2690÷2692
- ASME B16.5
- ASME B16.21
- ASME B16.47
- ISO 7483
- EN 1514-1
- EN 12560-1

In case when the full data is not provided, standard gaskets will be produced:

- default standard: EN 1514-1 (DN and PN); EN 12560-1 (DN/NPS and CLASS)
- default normative dimension type IBC
- default thickness: 2 mm up to DN 400 (NPS 16")
3 mm from DN 450 (NPS 18")
- default PN/CLASS: PN 10-40 up to DN 80
PN 16 from DN 100
CLASS 150 for all the NPS

* – please contact SPETECH if the specified values are higher



SOFT MATERIALS SEALS



PTFE BASED SEALS (EXPANDED PTFE) GORE™, SPETOFLON® TEX

Designation	Sketch	Description
GORE™ SERIES 500		GORE™ Series 500 gasket tape helps to achieve greater sealing efficiencies with large steel piping and equipment. Unlike sheet gasketing, it can be quickly formed in place, installs easily, and reduces expensive material scrap. GORE™ Series 500 gasket tape is the ideal choice for sealing large diameter flanges. Made from 100% multi-directionally expanded PTFE, it combines superior sealing performance and efficiency. Tighter and more creep resistant than other gasketing alternatives, it also has the advantages of a form-in-place sealing solution. Without “donut hole” scrap from cutting, it is often more cost effective. Because it is customized at installation, long lead times are eliminated and gasket inventories are reduced. Conformable and highly compressible, this tape forms a very tight seal. Strong multidirectionally expanded PTFE gives excellent creep resistance for a long-lasting seal that withstands virtually any chemical process.
GORE™ SERIES 600		GORE™ Series 600 gasket tape is a form-in-place gasket for glasslined equipment that guards against premature gasket failure. Unlike PTFE envelope gaskets, it will not degrade due to chemical attack, and will ensure a tight and long-lasting seal. GORE™ Series 600 gasket tape is the ideal choice for sealing large diameter flanges. Made from 100% multi-directionally expanded PTFE, the entire gasket is chemically inert. As a result, the user will not experience the sealing problems associated with aggressive media or outside environments. This unique gasket tape conforms to the imperfections common in glass-lined flange surfaces, while maintaining dimensional stability for superior sealing reliability. This gasket tape can be installed easily and quickly, yielding initial savings. And since it minimizes unexpected process upsets, process productivity gains are also achieved.
GORE™ SERIES 800 Universal Pipe Gasket		GORE™ Series 800 are gaskets combining the qualities of expanded PTFE resistant to medium transfer (diffusion); they are used for flanges of fixtures made of delicate materials where little assembly stresses are achieved. They assure durable tightness, even in changeable working conditions of the flange.

SOFT MATERIALS SEALS



PTFE BASED SEALS (EXPANDED PTFE) GORE™, SPETOFLON® TEX

Designation	Sketch	Description
GORE™ GR		GORE™ GR is a sealing sheet and gasket manufactured from multi-directionally oriented expanded PTFE; in order to improve installation properties, the sheet is harder and has higher density, which is important while installing the gaskets in the vertical flanges, especially in case of medium and large diameters; SPETOFLON® FGR-R sheet available as an alternative.
SPETOFLON® TEX DF		SPETOFLON® TEX DF is a joint sealant in the form of tape from mono-directionally orientated expanded PTFE, the most common of all “formed in place” sealing solutions; the sealant has excellent forming characteristics even to the worn and damaged surfaces, cutting the ends of the tape using skiving technique is not necessary during the installation; the risk of relaxation and cold flow is limited due to small thickness of the sealant in the flange, tape with adhesive strip, available in 9 sizes; sealant considered necessary for the maintenance services; as an alternative GORE™ DE joint sealant also available.
SPETOFLON® TEX DE		SPETOFLON® TEX DE is the modern generation of sealants formed in place, has rectangular cross section of even distribution of density in the one-directionally expanded PTFE; such construction allows for application of narrower sealants instead of traditional solutions, i.e. SPETOFLON® TEX DF (GORE™ DF), the sealant is available in 5 sizes due to wider application range, which substitute 9 sizes of DF sealant; as an alternative, GORE™ DE joint sealant also available.



SOFT MATERIALS SEALS



PTFE BASED SEALS (EXPANDED PTFE) GORE™, SPETOFLON® TEX

Designation	Sketch	Description
SPETOFLON® TEX FGR		SPETOFLON® TEX FGR material and gasket manufactured from multi-directionally expanded PTFE in a proprietary technology; easily formable material, easy to cut by means of the simplest tools, may be used as a universal sealing material.
SPETOFLON® TEX FGR-H		SPETOFLON® TEX FGR-H is composed of the core made from sintered PTFE and two layers of SPETOFLON® FGR ; such design reduces active area of the gasket, therefore it can be installed with low assembly loads, e.g. in epoxy-fibre composite flanges; due to PTFE core other materials are not introduced and exposed to the sealed medium; gasket is a very economical solution and is able to seal irregular flange surfaces.
SPETOFLON® TEX FGR-F		SPETOFLON® TEX FGR-F is manufactured by pre-forming SPETOFLON® TEX FGR gasket which reduces the active sealing area on one hand, on the other, closes the paths between anti-diffusion zones, this version is designed for the non rigid flanges e.g. from epoxy-fibre composite and similar; gasket's sealability is not affected by the load changes; additionally, easily formable in the irregular flange faces.
SPETOFLON® TEX FGR-J		SPETOFLON® TEX FGR-J gasket composed of the corrugated 316 L stainless steel ring (other materials on agreement) and two layers of SPETOFLON® FGR (GORE™ GR as an option); thanks to the corrugated metal ring the gasket has improved recovery, strength, resistance to relaxation and blowout; it is a gasket highly recommended for dangerous media (toxic, explosive, etc.); it is necessary to choose the metal compatible with the sealed medium.

SEALS IN PTFE ENVELOPES SPETOFLON® FU, FY, FC

Service parameters

T (°C)	-200 ÷ +260	120*
P _{max} (bar)	100	40*
Q _{max} (MPa)	90	60*

Widely used in:

chemical installations, pharmaceuticals, food, laboratories of high requirements for the quality of the product, its chemical resistance or ability to sterilise the installation, enamelled, rubber lined or plaited vessels and reactors, plastic pipelines, plastic lined glass, valves and laboratory fittings and installations.

Custom styles:

- reverse envelope for gaskets exposed to medium acting on their outer circumference or envelopes protecting inner and outer part of the insert
- gaskets manufactured as PTFE layers + inner/outer eyelet made also from PTFE for various shapes of gaskets (e.g. elliptical)
- full face gaskets with bolt holes
- gasket with engineered contact surfaces increasing local compression
- jackets from filled PTFE
- inserts from material in accordance with individual requirement (any material for shape)
- gaskets with additional anti-difusion barrier from ePTFE
- gaskets with specially engineered surface of the inner circumference which minimizes non-active area of the gasket
- gaskets with locating lugs to aid assembly

General informations

Ordering:

- for gaskets obeying EN 1514-3, please indicate the symbol, thickness, DN, PN, the standard number, e.g. SPETOFLON® FY BAS® 300, 3 mm, DN 100 PN 25, IBC, EN 1514-3
- for gaskets obeying EN 12560-3, please indicate the symbol, thickness, DN, CLASS, the standard number, e.g. SPETOFLON® FU GUS® 20 J, 5 mm, DN 250 CLASS 150, EN 12560-3
- please provide the dimensions or a drawing of non-standard gaskets





Availability:

Gaskets according to the following norms:

- EN 1514-3
- EN 12560-3

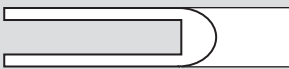
* – please contact SPETECH if the specified values are higher

SEALS IN PTFE ENVELOPES SPETOFLON® FU, FY, FC

Designation	Sketch	Description
SPETOFLON® FU		SPETOFLON® FU envelope is manufactured from virgin, sintered PTFE of 2,10 g/cm ³ density in the profile shown on the drawing; the jacket has anti-diffusion zone on the inner circumference which protects the material of the insert from contact with medium; thickness of the insert in practice is not limited; gasket's construction minimizes non-active space in the joint and provides erosion resistance in case of high flow velocity of the medium.
SPETOFLON® FY		SPETOFLON® FY envelope manufactured by means of slitting PTFE rings and is an economical alternative to FU envelope; recommended maximum thickness of the insert in FY envelope is 2mm, thickness of the PTFE envelopes, similarly to FU style, 0.5mm
SPETOFLON® FC		SPETOFLON® FC envelope is made in a technology of plastic forming, and it preserves full chemical resistance of PTFE, at the same time assuring economical material use; it is recommended for large diameters. In case of high diffusion by a relatively thin wall, FC P with additional anti-diffusion barrier is used.
SPETOFLON® FU BAS® 300		Gaskets manufactured by inserting SPETOBAR® BAS® 300 gasket into SPETOFLON® FU envelope for the service temperatures up to 150°C at small and medium diameters; PTFE envelope gives excellent chemical resistance and BAS® 300 improves recovery and inhibit creep relaxation of PTFE; gasket may be equipped with centring ring from SPETOBAR® BAS® 300 , thus the envelope has the same width as flange faces (in this case additional designation "Z").

SEALS IN PTFE ENVELOPES SPETOFLON® FU, FY, FC

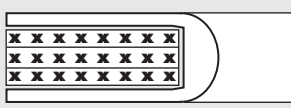
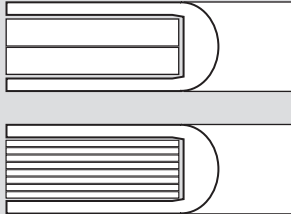
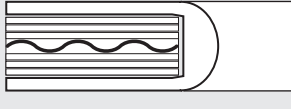
Designation	Sketch	Description
SPETOFLON® FU TUI 70		Gaskets manufactured by inserting ceramic felt ring SPETOTERM® TUI 70 into SPETOFLON® FU envelope; such construction gives very good conformability but its recovery is very limited; applied in enamelled flanges at low pressures.
SPETOFLON® FU GUS® 20 SPETOFLON® FU GUS® 40		SPETOFLON® FU GUS® gaskets with inserts from SPETOGRAF® GUS® 20 or GUS® 40 have the best resistance to ageing, recovery, compressive strength and temperature limit of 260°C; due to its reinforcements and thermal stability especially at high compressive loads and elevated temperatures SPETOGRAF® GUS® 40 is recommended as the insert; width of the envelope may be limited to the flange face area, whereas centring (types with "Z" index) can result from selection of the appropriate dimensions of the insert.
SPETOFLON® FU GUS® 20 J		SPETOFLON® FU gaskets have corrugated ring (types with "J" index) and two soft layers which allow for very thick constructions (e.g. 10.5mm) accomodating large inequalities (even several milimeters) in the enamelled flange faces; also in this case the best ageing characteristics, good recovery, excellent conformability have the gaskets with insterts from SPETOGRAF® GUS® 20 i SPETOGRAF® GUS® 40 for temperatures up to 260°C; SPETOTERM® TUI 70 insert has very good conformability but due to limited recovery it is recommended for lower pressures; SPETOBAR® BAS® 300 inserts are very good for the service conditions up to 150°C also when the pressure will change but thei conformability is worse than SPETOGRAF® GUS® or SPETOTERM® TUI 70 ; special styles may have two corrugated rings with a flat steel insert between them, e.g. FU GUS® 40 JIJ lub FU GUS® 40 JIJZ , index "Z" indicates that metal element performs the centring function.

SEALS IN PTFE ENVELOPES SPETOFLON® FU, FY, FC

Designation	Sketch	Description
<p>SPETOFLON® FU MWK® 50</p> <p>SPETOFLON® FU MPL® 12</p>		<p>Kammprofile gaskets, e.g. SPETOMET® MWK® 50 or MWK® 60 in SPETOFLON® FU envelope; this construction prevents the contact between metal and the sealed medium; while selecting dimension of the kammprofile gasket, thickness of the PTFE envelope must be considered; in case of the insert from corrugated ring, it can be applied together with SPETOFLON® FU envelope covering the ring (FU MPL® 12) or only its sealing area (FU MPL® 12 Z).</p>
<p>SPETOFLON® F BAS® 301</p> <p>SPETOFLON® F GUS® 21</p>		<p>Gaskets manufactured from soft material of good elasticity and strength characteristics selected for the service temperature, with two layers of PTFE foil and metal inner eyelet increasing blowout resistance and preventing chemical degradation of the gasket material by the contained medium and gives erosion resistance in case of graphite inserts; soft material inserts from SPETOBAR® BAS family (recommended BAS® 300) or SPETOGRAF® GUS® 20 is recommended for lower temperatures and loads whereas GUS® 40 for more severe service conditions); metal eyelets from chrome-nickel steel; the construction is an economical alternative to FU or FY envelope gaskets but applicable only in steel flanges.</p>



FIBER BASED GASKETS SPETOBAR® BAS® 300, BAS® 340 STYLES

Service parameters

T (°C)	-50 ÷ +280	120*
P _{max} (bar)	200	40*
Q _{max} (MPa)	180	120*

Widely used in:

sealing material for power generation, petrochemical industry and refineries, chemical, heat plants, steel works, machine industry; applied in the flanges with PN and class designations, valves, pumps, apparatus, vessels, gas installations, water heating installations, radiators, also in internal combustion and diesel engines, e.g. for sealing intake manifolds; vacuum pumps, hot water installations, compressors, cooling systems.

Custom styles:

- full face gaskets with bolt holes
- gaskets with bars or of shapes other than round
- gaskets with graphited surfaces
- gaskets from segments or cut spirally and joined in puzzles
- gaskets with ePTFE strip to improve conformability
- gaskets with adhesive backing strip

General informations

Ordering:

- for gaskets obeying EN 1514-1, DIN 2690, DIN 2691, DIN 2692, ISO 7483 please indicate the symbol, thickness, DN, PN, and for EN and ISO standards, the type (IBC, FF, TG or SR according to EN 1514-1), the standard number, e.g. SPETOBAR® BAS®, 2 mm, DN 50 PN 40, IBC, EN 1514-1
- for gaskets obeying EN 12560-1, please indicate the symbol, thickness, DN, CLASS, the type, the standard number, e.g. SPETOBAR® BAS® 340, 2 mm, DN 50 CLASS 150, IBC, EN 12560-1
- for gaskets obeying ASME B 16.21 please indicate the symbol, thickness, NPS, CLASS, the standard number, e.g. SPETOBAR® BAS® 340, 2 mm, NPS 2" CLASS 150, ASME 16.21
- please provide the dimensions or a drawing of non-standard gaskets, or any special requirements, e.g. "for oxygen"

Availability:

Gaskets:

- DIN 2690÷2692, DIN 7168
- EN 1514-1
- EN 12560-1
- ASME B 16.5, B 16.21, B 16.47
- Sheets: 1500x1500 th. 2; 3; (4); (5) mm

In case when the full data is not provided, standard gaskets will be produced:



- default standard: EN 1514-1 (DN and PN); EN 12560-1 (DN/NPS and CLASS)
- default normative dimension type IBC
- default thickness: 2 mm up to DN 400 (NPS 16")
3 mm from DN 450 (NPS 18")
- default PN/CLASS: PN 10-40 up to DN 80
PN 16 from DN 100
CLASS 150 for all the NPS

* – please contact SPETECH if the specified values are higher

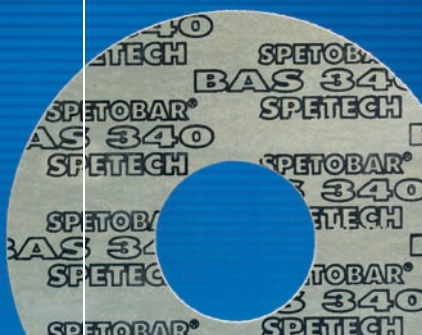
SOFT MATERIALS SEALS



FIBER BASED GASKETS SPETOBAR® BAS® 300, BAS® 340 STYLES

Designation	Sketch	Description
SPETOBAR® BAS® 300		<p>SPETOBAR® BAS® 300 is a material based on aramid fibres and other non-asbestos fillers bonded by mix of high quality elastomers in the special calendring process; the material has good forming properties, low permeability, good mechanical properties and withstands high temperatures; it can be applied as a “universal” sealing solutions within the range of medium temperature and mechanical loads; material can work in services with exposure to oxygen; as standard, BAS® 300 has anti-adhesion surfaces of high coefficient of friction; used in hydraulic, cooling systems (containing freon and based on water cooling agents), water solutions, fuels, solvents, de-freezing agents, alkalis.</p>
SPETOBAR® BAS® 340		<p>SPETOBAR® BAS® 340 is a non-asbestos sheet or a gasket based on aramid fibres, non-organic fillers with high quality elastomer as a binder, manufactured in a multi-stage calendring process, has mechanical and temperature characteristics distinguishing it from other fibre materials; it is physiologically safe, without any pigments, exhibits excellent tensile strength, shearing and stress resistance; in service with gas and liquids, e.g. oils, fuels, freons, liquid gases, solvents, hot water and steam but without pressure and temperature fluctuations¹⁾; easy to handle, exhibits outstanding chemical resistance and ability to work in high pressures; Surface treatment: as standard, SPETOBAR® BAS® 340 is coated with a nonstick agent of high coefficient of friction (stabilizes the gasket in the joint), therefore no further steps to improve surface characteristics are necessary; only in situations where relative movement is the case, sheet (gasket) may be delivered with graphited surface on one or both sides; BAS® 340 is one of the very few fibre materials that are fire-safe (BS 6755); may be exposed to oxygen, food, gas, potable water etc.</p> <p>¹⁾ – in case of hot water or steam installation with load cyclings, SPETOGRAF® gaskets are recommended.</p>



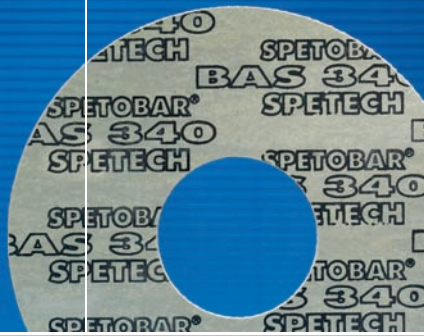

FIBER BASED GASKETS SPETOBAR® BAS® 300, BAS® 340 STYLES

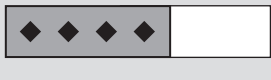
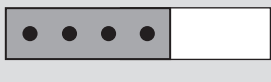
Designation	Sketch	Description
SPETOBAR® BAS® 340 I		SPETOBAR® BAS® 340 I is the sheet manufactured from the same fibre-elastomeric mix as SPETOBAR® BAS® 340; therefore it has similar properties as per chemical resistance, resilience, physiological safety, resistance to ageing etc.; it is, however, equipped with 0.5mm thick, mesh 1.4404 stainless steel reinforcement, this reinforcement increases tensile strength, resistance to stress and resilience, also makes the gasket more rigid which is important during the installation; thanks to the reinforcement, the material can withstand higher pressure and/or temperature loads which is important in hot water or steam service; also reinforcement does not have negative influence on permeability, due to the special technological process; BAS® 340 I is used in chemical industry, refineries, power plants, coke plants, in all places where substantial pressure and temperature loads occur and where the flange faces are narrow, BAS® 340 I has a non-stick top and bottom layer of high coefficient of friction; in special version – when used in components which rotate on the gasket during assembly, a graphite coating on one or both sides of the gasket is required.
SPETOBAR® BAS® 340 R		SPETOBAR® BAS® 340 R is a sheet made of the same fibre and elastomeric composition as SPETOBAR® BAS® 340; it has internal reinforcement of zinc-plated carbon steel net which increases its resistance for tearing, squeezing and cutting.

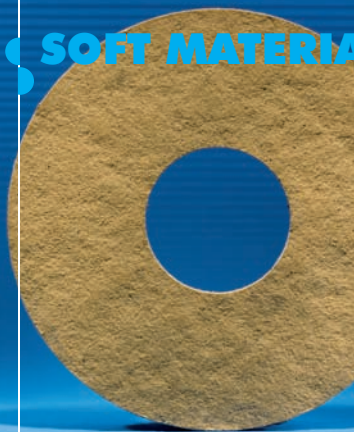

SEALS FROM MICA / CERAMIC / GLASS FIBERS SPETOTERM® TUI

Service parameters

T (°C)	-10 ÷ +1300	700*
P _{max} (bar)	40	0.5*
Q _{max} (MPa)	120	1*

Widely used in:

power generation, refineries, heat generation, steel works, glass production, pulp and paper, shipyards, chemical industry, gaskets used in nonpressurized air installations, coal dust system, exhaust installations, furnace and boiler chamber covers, burners, in all places where the temperature is high, but without pressure; used also to contain oxidizing media, such as nitric acid, sulphur trioxide etc. in pressure installations; gaskets have very good chemical and fire resistance.

Custom styles:

- TUI 50 packings with graphite or PTFE impregnation improving sealability
- insert as the centring ring
- metal insert from selected material, e.g. nickel alloys
- full face gaskets with bolt holes
- metal insert with elements facilitating assembly, such as locating lugs
- parts from TUI 820 as thermoinsulating elements

General informations

Ordering:

- for gaskets obeying EN 1514-1, DIN 2690, DIN 2691, DIN 2692, ISO 7483 please indicate the symbol, thickness, DN, PN, and for EN and ISO standards, the type (IBC, FF, TG or SR according to EN 1514-1), the standard number, e.g. SPETOTERM® TUI 831, 2 mm, DN 50 PN 40, IBC, EN 1514-1
- for gaskets obeying EN 12560-1, please indicate the symbol, thickness, DN, CLASS, the type, the standard number, e.g. SPETOTERM® TUI 831, 2 mm, DN 50 CLASS 150, IBC, EN 12560-1
- for gaskets obeying ASME B 16.21 please indicate the symbol, thickness, NPS, CLASS, the standard number, e.g. SPETOTERM® TUI 831, 2 mm, NPS 2" CLASS 150, ASME 16.21
- please provide the dimensions or a drawing of non-standard gaskets, or any special requirements, e.g. "for oxygen"

Availability:

Flat gaskets: TUI 70, TUI 70I, TUI 810

- EN 1514-1
- EN 12560-1
- ISO 7483
- TUI 50 packing: square cross section 8÷50mm

In case when the full data is not provided, standard gaskets will be produced:

- default standard: EN 1514-1 (DN and PN); EN 12560-1 (DN/NPS and CLASS)
- default normative dimension type IBC
- default thickness: 2 mm up to DN 400 (NPS 16")
3 mm from DN 450 (NPS 18")
- default PN/CLASS: PN 10-40 up to DN 80
N 16 from DN 100
CLASS 150 for all the NPS

* – please contact SPETECH if the specified values are higher

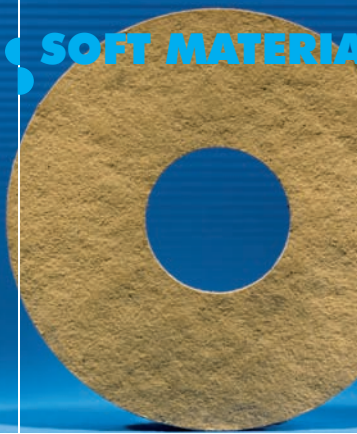

SEALS FROM MICA / CERAMIC / GLASS FIBERS SPETOTERM® TUI

Designation	Sketch	Description
<p>SPETOTERM® TUI 50S</p> <p>SPETOTERM® TUI 50S75</p> <p>SPETOTERM® TUI 50C</p> <p>SPETOTERM® TUI 50CR</p>		<p>SPETOTERM® TUI 50 is the square braided packing, used to seal the furnace doors, installations containing melted metals in steel works, fire-safe zones in the pipelines, thermal dilatations, ship hauls; the packing may be also impregnated with graphite or PTFE; depending on material used the following styles can be distinguished: TUI 50 S glass fibre up to 450°C; TUI 50 S75 high temperature glass fibre up to 750, TUI 50 C ceramic fibre up to 1000°C (1200°C), TUI 50 CR – ceramic fibre with wire reinforcement up to 1000°C (1200°C); due to ecological consideration, the sealing is manufactured from special glass fibre S75.</p>
<p>SPETOTERM® TUI 70 N 85</p> <p>SPETOTERM® TUI 70I N110</p> <p>SPETOTERM® TUI 70J 120</p>		<p>SPETOTERM® TUI 70 is a ceramic fiber based, high temperature resistant static gasket. SPETOTERM® TUI 70I gasket family is manufactured from the same materials as for TUI 70 series, but have the steel core; such gasket has better mechanical stability in service, and importantly during assembly; steel core allows for the production of the gaskets with dimensions exceeding those of sheet, depending on the material used the following styles are available: TUI 70I N85 (up to 850°C), TUI 70I N110 (up to 1100°C), TUI 70I B120, TUI 70I G120 (up to 1200°C) the difference between TUI 70I B120 and TUI 70I G120 lies in conformability of the layers; in the latter case, layers are much harder which results in thicker gasket after assembly, typically, metal core is manufactured from carbon steel.</p>



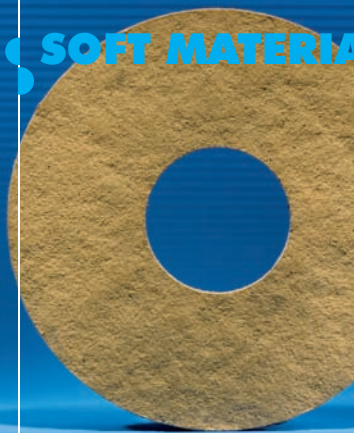

SEALS FROM MICA / CERAMIC / GLASS FIBERS SPETOTERM® TUI

Designation	Sketch	Description
<p>SPETOTERM® TUI 810</p> <p>SPETOTERM® TUI 810 J</p> <p>SPETOTERM® TUI 811 I</p>		<p>SPETOTERM® TUI 810 is a soft, easily formed material, manufactured from flogop plates bonded with special silicone filler, fibre-free material, main applications: exhaust systems, sealing of heat furnaces, for strongly oxidising fluid media and heat shields; material can be punched, cut with knife or special cutters; often delivered as full face gasket, standard thickness 1mm, also available in thicknesses 2.0, 3.0 mm; standard sizes of the sheet 1000x1000mm; for dimensions above 1000mm recommended form of delivery is the gasket on the steel core TUI 810 I, soft elements of the gaskets may then be made from segments, recommended service temperature up to 750°C.</p>
<p>SPETOTERM® TUI 810 I</p> <p>SPETOTERM® TUI 811 J</p>		<p>SPETOTERM® TUI 810 J gasket is manufactured in the similar way to TUI 810 I, but corrugated ring is used as the metal core, which improves recovery, ensures better forming when the flanges are misaligned or uneven, corrugated ring also creates beneficial effect of higher loads in the areas of the corrugation peaks, which improves sealability, thickness of corrugated insert 1.5mm, also in this case, metal ring facilitates manufacture of segment gasket of dimensions over 1000mm.</p>
<p>SPETOTERM® TUI 830</p>		<p>SPETOTERM® TUI 830 is the standard material used in manufacture of gaskets with perforated stainless steel core; mica flakes bonded with special binding agent show almost absolute inertness in contact with strongly oxidising media such as HNO₃ lub H₂SO₄ even at elevated temperatures; stainless steel reinforcement improves mechanical strength of the material, however, its application is limited to approximately 650°C, in order to achieve better sealability inner steel or silver eyelet is recommended (TUI 831).</p>

3. SPECIAL SEALING SYSTEMS

3.1. DOUBLE SEALING SYSTEMS	55
3.2. BAFFLE SEALS	56
3.3. PLATE HEAT EXCHANGERS SEALS	57
3.4. SELF-ENERGIZED SEALS	58
3.5. COVER PLATE GASKETS	61
3.6. VALVE SEALS PROGRAM	63







DOUBLE SEALING SYSTEMS

Double Sealing Systems become more popular relating to the increasing safety and reliability of plants, recently improved anti-emission 'Clean Air Acts', enlarged intervals between maintenance periods.

The double sealing systems are used in bolted flange connections of apparatus, valves and pipelines. Historically some first applications took place in Nuclear Power Plants where highest tightness / reliability factors are used since beginning. Nowadays **Double Sealing Systems** are one of Best Available Technology (BAT) solution that are provided more widely by Spetech to the market.

Typical place of application are:

- still the nuclear plant connection requiring highest reliability and leakage proofness technology,
- pressure vessels and Installations (pipelines) especially in the chemical industry for application with hazardous substances (toxic, odorous, explosive, or any other) also big-size reservoirs for hazardous liquids / gases / liquid gases.

Designation	Sketch	Description
SPETOMET® MWK® 28 / SPETOGRAP® 10		<p>The construction of Spetech Double Sealing Systems is that a more rigid gasket (having less compressibility) with a high spring rate e.g. Dryflex or GUS 660 gasket is used for the gasket in the main-load. In the same construction as the secondary gasket (which is put in the off-load position) should be used gasket with higher compressibility factor (for example spiral wound type or pure graphite layers).</p> <p>How does it work? Function of primary seal is to ensure tightness and reliability of the connection (it works as classic gasket). Hence secondary seal is not exposed to high pressure any more and than secondary seal may be used just to stop any eventual leaks (passing through primary seal or any welds in monitored area). Being such barrier secondary seal lets to dispose leaks to leakage measuring devices in aim to provide continuous control of tightness of the connection. If the rate of leakage rise – this is the information that something wrong is starting with the gasket / welds inside monitored area</p>
SPETOMET® MWK® 50 / SPETOSPIR® SWZ		<p>The selection of Double Sealing System to be used for the gaskets in the main-load and the off-load may be calculated by Spetech individually to customers request. The aim of this customized calculation is to proof the excellent tightness of the joint from one hand and and from the other hand such calculation let to estimate flange rotation that occurs in the moment of installing the Double Sealing System and to prevent from bad results of such rotation.</p>
GUS® 660/ SPETOSPIR® S		



BAFFLE SEALS SPETOMET® YY4

WITHOUT BAFFLE SEAL

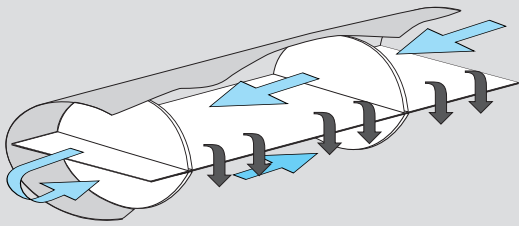

WITH BAFFLE SEAL

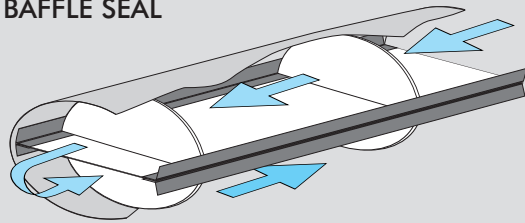

BAFFLE SEAL

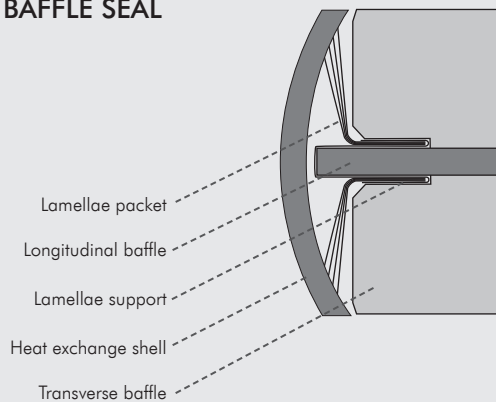

The Baffle Seal is a special kind of fully metal seal. Different from any other flange seals described in this catalogue Baffle Seal is a particular seal also forecasted for pressure vessels (heat-exchangers and others), but different from other seals located inside the equipment with function of sealing gaps between of longitudinal edges of the baffles with the inner side of shell.

In old fashioned equipment with no usage of baffle seal suffered of efficiency decrease of due to undesired exchange between opposite mediums (e.g hot / cold) chambers via narrow gap along baffle and shell. Usage of SPETECH multi lamellas baffle seal prevent from such undesired scheme.

Although this solution may look as very basic and not sophisticated and Baffle Seal is never 100% leakproof, applying it is one of most easy any efficient way to increase output of multi chambers process vessels.

The baffle seal is easy installed onto the longitudinal baffle yet while it is outside the shell. Thanks to its springy and self clenching construction customer receive a baffle seal ready to install with no need to use any special tools, screws, bolts during installation. Just put the Baffle Seal along the baffle (when it is yet outside the shell) and drive into the shell of the vessel. Finish.

Spetech supplies Baffle Seals acc. to length required by final user. The standard material is grade 316 steel, but many other (see Common Used Material table.) may be used. Purely metal construction ensures safe functioning over a wide temperature range and made Baffle Seal resistant to long time ageing process.

The lamellae of baffle seal and the lamellae holder are joined together by spot-welds, thus forming one unit ready to install being very solid and having excellent lamellas spring back effect. As standard two sizes of lamellas holders widths are available 20mm and 30mm. Holders are available for thickness 4 mm up to 25 mm of the longitudinal baffle

SPECIAL SEALING SYSTEMS

SEALS FOR PLATE HEAT EXCHANGERS

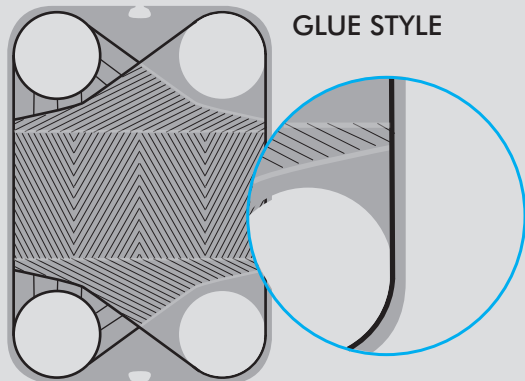

GLUE STYLE

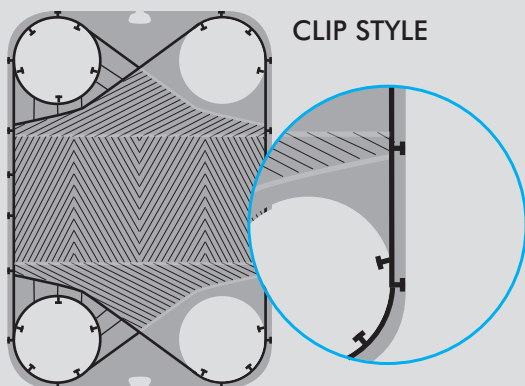

CLIP STYLE

In some industries instead of Shell & Tube plate type heat exchangers are widely popularized. Their major advantage to use plate type heat exchangers, is that the corrugations in the plates reduce the liquid turbulence to a very limited level and the liquids flow is counter current so that the heat transfer efficiency is always 3-5 times higher than Shell & Tube type heat exchangers.

Plate heat exchangers in their structure are composed of a fixed frame, a movable frame and corrugated plates which are in between the two frames. Hot liquid and cold liquid go through between the corrugated plates in turn the areas separated by elastomer paths of seals. Most popular plate heat exchanger producers are APV, AGC, Alfa Laval, Arsopi, Barriquand, Cetetherm, Ciat, Cipriani, Fischer, Fiorini, GEA, Hisaka, Mueller, Pasilac, Reheat, API Schmidt Bretten, Silkeborg, Sondex, Swep, Tranter, Vicarb.

To prevent leaking, a fine elastomer for the gasket is installed around the plates and big tightening bolts are used to put the plates together. Construction of the Plate heat exchangers makes the seals a critical part of this equipment responsible for the life-time of all the equipment. Depending on process medium the gasket must be chemically resistant and/or temperature resistant. Spetech is providing seals to most existing plate heat exchangers working in: power industry, oil processing, food and beverage industry, sugar industry, chemistry, pulp and paper.

Most popular materials used are: NBR, HNBR, EPDM, FPM (different grades).

There are two basic ideas of installing the seals: Glue Style Gasket and Clip Style Seals. Clip style gaskets are installed without any adhesive. This improvement lets fitting of the gasket on the plate just by installing clips into grooves on the plate. Hence gasket is high resistance against pressure and enables for a quick and simple replacement.

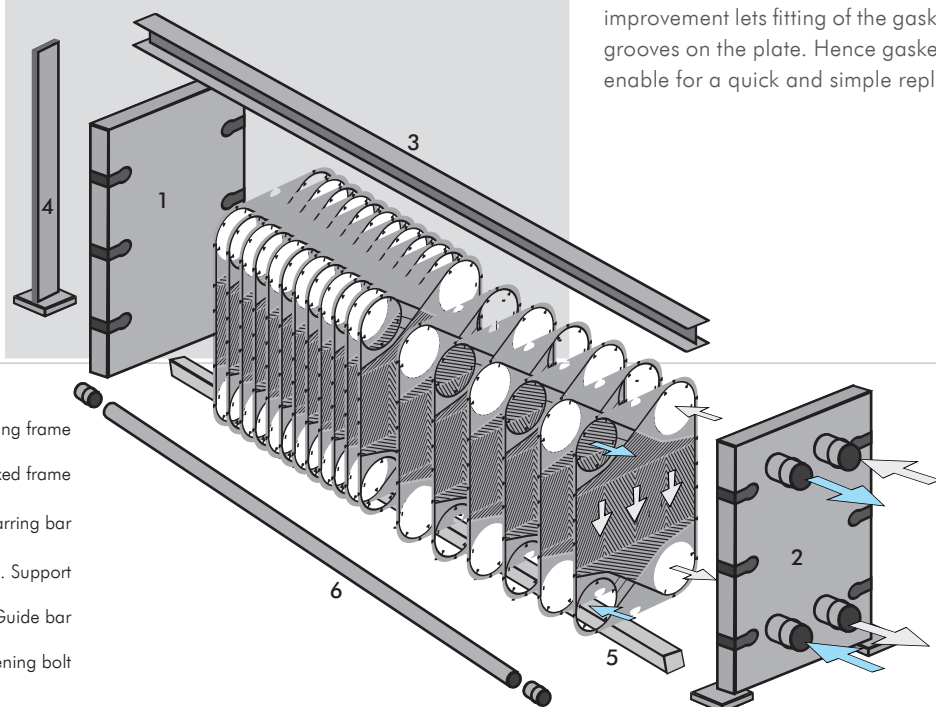

- 1. Moving frame
- 2. Fixed frame
- 3. Carrying bar
- 4. Support
- 5. Guide bar
- 6. Tightening bolt



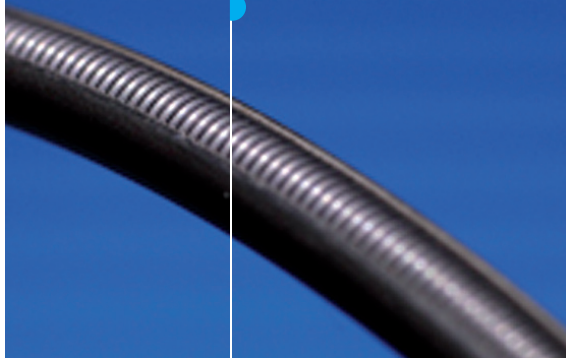

SELF-ENERGIZED SEALS SPETOACTIV® R, P

Service parameters

T (°C)	-200 ÷ +870	260*
P _{max} (bar)	10 000	350*
Q _{max} (MPa)	indefinite	

Ordering:

- please indicate the fixing dimensions and sealing conditions. The type, material and dimensions are custom-made

Availability:

- for flanges according to AS 1895
- according to American Military Norm USA MS 9141, MS 9142÷9205, MS 9371÷MS 9376

General informations

Widely used in:

metal gaskets SPETOACTIV® are used in extremely difficult applications and when the seating space is limited (due to limitation of weight or dimensions of the joint) or at the highest service requirements; these are aeroplane jet engines, rocket engines, nuclear power engineering, oil and gas industry; SPETOACTIV® based on PTFE with additional metal spring element are used instead of elastomeric o-rings to seal the bearings, in the valves, plunger pumps, mechanical seals and in static applications, where, due to the temperature, medium, volume or speed of relative movement the solution of higher reliability are demanded; self-energized PTFE gaskets are also used in the static applications, because of the lower requirements as per the flange face surface finish compared to metal equivalents. All SPETOACTIV® gaskets need to be installed in the special flange arrangements or require an adaptor.

Materials of SPETOACTIV® P

jacket material	min. temperatures°C	max. temperatures°C
virgin PTFE	-250	200
PTFE + graphite	-150	230
PTFE + MoS ₂ glass fibre	-150	260
PTFE +60% bronze	-150	290
PTFE + carbon	-150	270



Materials of SPETOACTIV® R

jacket material	available types	max. temperatures°C
304	R-0	430
316	R-0	430
321	R-0	430
347	R-0	430
Alloy 718	R-C, R-E, R-0, R-U	650
Hastelloy C	R-C	760
Waspaloy	R-C, R-E, R-U	870

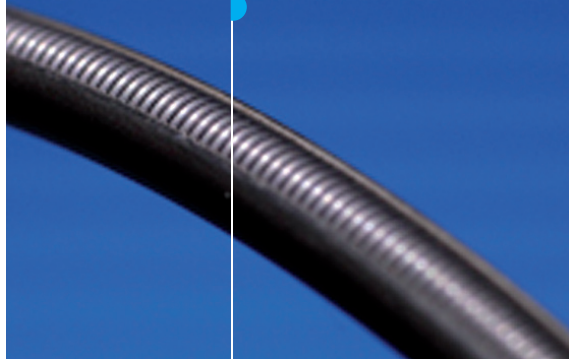
* – please contact SPETECH if the specified values are higher

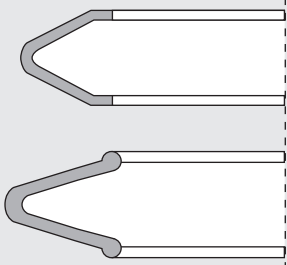

SELF-ENERGIZED SEALS SPETOACTIV® R, P

Designation	Sketch	Description
SPETOACTIV® R-O		SPETOACTIV® R-O gasket (metal o-ring) is applied in very rigid joints where the requirements for the tightness are high; gaskets may be delivered in sizes up to 5000 mm; easy to install; may be additionally coated with PTFE, silver, lead, which facilitates forming on the flange face; manufactured as interannly pressurized and non-pressurized to increase contact stress, made of various materials and in different dimension standards; may be used (when the dimensions of the joint arrangement is appropriate) in installations with external and internal pressure; SPETOACTIV® R-O may also work in the triangle flange arrangement and seal three surfaces.
SPETOACTIV® R-C		SPETOACTIV® R-C gasket (metal C-ring) is one of the most popular self-energized gaskets manufactured in dimensions up to 3000 mm; used in uneven flange faces; available in different materials, sizes and with various coatings; this solution can be applied for service conditions (depending on the material used) up to 870°C and 170MPa; relatively good resilience; depending on the load the appropriate construction of the gasket should be chosen, due to the fact that C-ring's service depends on the direction of the pressure; in special styles gaskets may be equipped with the inner metal spring increasing initial loads and tightness, so that they may be applied at low pressures.
SPETOACTIV® R-CS		The SPETOACTIV® R-CS gasket (so-called metal C-ring with a spring) is equipped with an internal spring increasing initial pressure, and consequently the tightness and the possibility to work with low and high pressure, it has got durable, high flexible recovery.
SPETOACTIV® R-U SPETOACTIV® R-UM		SPETOACTIV® R-U gasket (metal U-ring) can be applied at low initial loads, has good recovery characteristics, ability to compensate for the uneven and flauty flange faces, so may be installed in the low rigidity joints; manufactured in many material types up to the diameter of 1200 mm, usually without the coating; for service conditions up to 870°C and 80MPa; like R-C i R-E styles, R-U gaskets care should be taken in order to choose appropriate construction due to the service requirements. SPETOACTIV® R-UM solid metal style is also available.

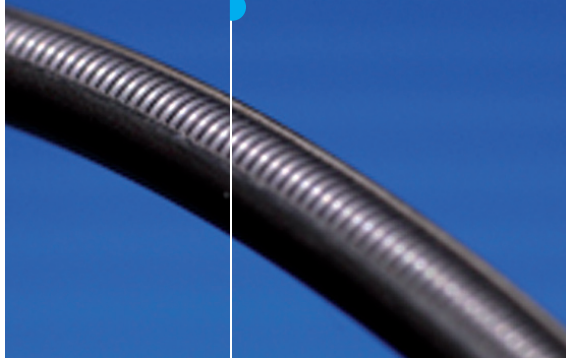

SELF-ENERGIZED SEALS SPETOACTIV® R, P

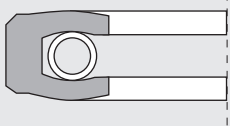
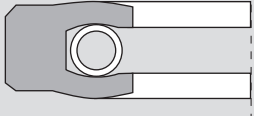
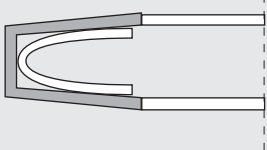
Designation	Sketch	Description
SPETOACTIV® P-20		SPETOACTIV® P-20 is a gasket manufactured from PTFE (or modified PTFE) with a special spring used in both static and quasi-static applications; choice of material is determined by service conditions and gaskets may work in pressure up to 55Mpa and temperatures from -250°C to +270°C; thanks to the internal spring it does not lose its recovery, therefore it is not affected by temperature and pressure fluctuations; special style with silicone o-ring instead of metal spring reducing non-active area of the gasket; direction of the pressure determines gasket's construction
SPETOACTIV® P-24		SPETOACTIV® P-24 is a gasket similar to SPETOACTIV® P-20 but applied in higher pressures, thus different external profile; may be manufactured from various kinds of modified PTFE, therefore can work in temperatures from -250°C to 270°C, maximum working pressure – 140 MPa.
SPETOACTIV® P-28		SPETOACTIV® P-28 gasket is used in criogenic technologies up to the pressure of 35Mpa; it is a only a static gasket of good elastic recovery; its spring has the construction compensating for the thermal shrinkage of the polimer material; may be delivered in many material options in dimensions up to 1200mm; the direction of the pressure acting on the gasket should be considered while its construction is engineered.



COVER PLATE GASKETS GRAFMET® 900 SERIES

Service parameters

T (°C)	-200 ÷ +650	500*
P _{max} (bar)	420	100*
Q _{max} (MPa)	500	200*

General informations

Ordering:

- for GRAFMET® rings and TRANSFLEX® packages please indicate the fitting dimensions or the type, nominal dimension and the manufacturer of the fixture.

Standard dimensions:

- The GRAFMET® and TRANSFLEX® gaskets are produced according to the dimension specification of the fixture manufacturers.

Widely used in:

The GRAFMET series 900 and TRANSFLEX® gaskets are used in high-pressure covers of pressure vessels, mainly in power industry. It is recommended to use products with metal inserts / reinforcements securing the gasket if it is to be used in high performance and/or high duty applications. In Cover Plate Gasket applications the necessary sealing force is provided by the internal process pressure and you may call it somehow self-tightening covers.

Custom styles:

- GRAFMET® 900 styles of other cross sections, such as square, trapezoid of requested dimensions

* – please contact SPETECH if the specified values are higher

COVER PLATE GASKETS GRAFMET® 900 SERIES

Designation	Sketch	Description
GRAFMET® 960		<p>GRAFMET® 960 is a die-formed ring from expanded graphite of 1.6 g/cm³ density and industrial or nuclear purity (GRAFMET® 960N), applied in valves and vessels as so called self-sealing gasket. The gap between the body and the cover, cover and the press ring, press ring and the body should not be bigger than 0.7mm for GRAFMET® 960; for bigger gaps and when contact stresses $\bar{\sigma} > 100$ N/mm², GRAFMET® 962 is recommended. At present, GRAFMET® 960 is reinforced with stainless steel foil. GRAFMET® 962, also of trapezoid cross-section, is externally reinforced by metal caps which prevent the extrusion of graphite when the gaps exceed 0.7mm and high contact stresses over 100N/mm² occur; additionally, the caps protect the graphite from erosion and oxidation; for big diametres and wide gaps, metal caps may be machined – GRAFMET® 962 M, such a sealing solution is most commonly applied in vessels to seal their covers. When the rings have rectangular cross section, their designations are accordingly GRAFMET® 970 and GRAFMET® 972 with machined caps.</p>
GRAFMET® 962		
GRAFMET® 970		
GRAFMET® 972		
GRAFMET® 960 R		
GRAFMET® 971		
TRANSFLEX® **		<p>The GRAFMET® 970 rings are available in a special TRANSFLEX® set containing metal sectional rings of variable dimensions enabling compensation of clearance, even large ones of unpredicted dimensions, on existing high-temperature great-flow fittings and/or apparatus and heat exchangers, under self-caulking covers. A soft component can be offered as a pre-formed graphite ring, e.g.: TRANSFLEX® 960/970, or woven packing, e.g.: TRANSFLEX® 960/880.</p> <p>Structures for rectangular stuffing-boxes are also available. In such a case, soft sealing component remains unchanged whereas two expanding rings are installed on the box bottom. This is the Transflex® 970/970 product.</p>

VALVE SEALS PROGRAM

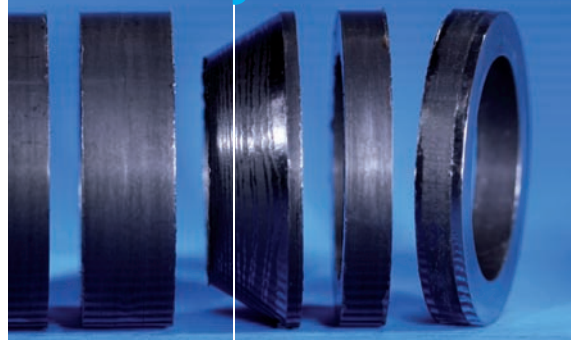

• Basing of 20 years' engineering experience both in flange gaskets (static) application and stuffing box (dynamic) applications Spetech jointed above two fields of experiences' and started provide complete 'Valve Seals solutions' for valve manufacturers.

Our production program covers: seat sealings, stem seals and bonnet connection gaskets and is continuously focusing towards in high parameters valves sealing solutions and provides sealing systems for '4xH valves' (4 x H are High Pressure / High Temperature (over 450°C) / High Tightness (TA-Luft / VDI) / High Duty valves).

Designation	Sketch	Description
SEAT SEALS		<p>Program includes:</p> <ul style="list-style-type: none"> • various construction of sealing discs / sealing seats of 2-off-set and 3-off-set used in BUTTERFLY valves (solid or laminated versions freely available) • solid metal, laminated metal-graphite or graphite with reinforcement spherical seats for the BALL valves (also seats integrated with the metal cover) • large number of types of secondary gaskets installed in the are of valve seats
STEM AND SHAFT SEALS		<p>Program includes:</p> <ul style="list-style-type: none"> • Single preformed rings made from pure expanded (GRAFMET® 950) graphite or from any braided packings used either alone or in the sealing sets. Our preformed rings (thanks to usage of first class quality materials) shows excellent non-ageing properties, creep resistance, high temperature resistance. Standard density of rings: 1.35 g/cm³ or 1.6 g/cm³ (other densities upon request). • 'Ready to install' sealing sets applied in the highest duty valves and fittings; composed of the GRAFMET® 950 family ring, braided packing rings or combination of them. Dimensions and configuration (e.g. typically 3 pieces of GRAFMET® 950 inside and 2 pieces of SPETOPAK® braided packing rings outside) upon request. • 'High Tightness' sealing sets being in compliance with various 'CLEAN AIR ACTS' (the tightness criteria like German VDI 2200 and can be regarded as a high-grade sealing system for the purposes of 'CLEAN AIR ACTS' eg. TA-LUFT. <ul style="list-style-type: none"> • special shape / special construction pure graphite rings (SPETOPAK WGR TA) or • specially prepared braided packings (SPETOPAK® WGR® 8515, SPETOPAK® WGR® 8535) combined with high density rings and special metal cap for high sealing performance especially for chemical and petrochemical box valves. • Please not that due to Best Abvailable Technogy priciples of SPETECH there are others 'High Tightness' packings sets in certification progress (e.g. SPETOPAK® WGR® 8530). If interesting in this area - please contact us for updated list of certified 'High Tightness' packings.

Please note that all the bonnet sealings which are used in valves are working as static application gasket and you can use from various combinations of seals described in whole this catalogue. Most popular types are: kammprofiles, spiral wound gaskets, pure graphite rings, self energized metal seals, etc.

4. GENERAL INFORMATION

4.1. COMMON USED MATERIALS	67
4.2. COMMON BARS SHAPES	70
4.3. GASKETS PARAMETERS	72
4.4. ESA INSTALLATIONS PROCEDURES	76





COMMON USED MATERIALS

SOFT MATERIALS

Designation	Material details	Compressibility ASTM F36	Elastic Recovery ASTM F36	Temperature* °C	
				from	to
FG-C	Sigraflex C graphite, C>98,00%	40÷50	10÷15	-200	550
FG-N	Sigraflex Z graphite, C>99,85%	40÷50	10÷15	-200	550
FG-APX	Sigraflex APX graphite with oxidizing inhibitor, C>98,00%	40÷50	10÷15	-200	650
TUI 810	Mica (ceramic)	20÷25	35÷40	-200	750
TUI 910	Wermiculite	30÷40	10÷15	-200	950
PTFE	Poli-Tetra-Fluoro-Ethylene	10÷15	45÷55	-250	260
ePTFE	Expanded Poli-Tetra- Fluoro-Ethylene	50÷60	15÷20	-250	260
AFM	Asbestos Free Material - fibre and elastomer	5÷15	5÷15	-50	150

Please note above data are approximate. Real values may vary depending from raw material source/ material treatment/ batch of material etc. Final values might be delivered after testing any of above materials in Spetech Sealing Material Testing Centre.

COMMON USED MATERIALS



METALS

Common name	Abbreviation	WR	UNS
Carbon Steels			
Carbon steel 235	S235JRG2	1.0038	
Vessel Steel 265	P265GH	1.0425	
Fine Carbon Steel 355	P355NL1	1.0566	
Soft Iron (e.g. Armco)	M2	1.1003	
Stainless Steels			
Stainless Steel 304 (304H)	X5CrNi18-10	1.4301	
Stainless Steel 316	X5CrNiMo17-12-2	1.4401	UNS S31600
Stainless Steel 316L	X2CrNiMo17-12-2	1.4404	UNS S31603
Stainless Steel 316L UG (Urea Grade)	X2CrNiMo18-14-3	1.4435	UNS S31603
Stainless Steel 317L	X2CrNiMo18-14-4	1.4438	UNS S31703
Stainless Steel 904L	X1NiCrMoCu25-20-5	1.4439	UNS N08904
Stainless Steel 321 (321H)	X6CrNiTi18-10	1.4541	UNS S32100
Stainless Steel 347	X6CrNiNb18-10	1.4550	UNS S34700
Stainless Steel 316Ti	X6CrNiMoTi17-12-2	1.4571	UNS S31635
Heat Resistant Stainless Steel 309	X15CrNiSi20-12	1.4828	UNS S30900
Incoloy 800 (800H)	X10NiCrAlTi32-20	1.4876	UNS N08800
Duplex Stainless Steels			
Duplex Steel F55	X2CrNiMoCuWN25-7-4	1.4501	UNS S32760
Duplex Steel F53	X2CrNiMoN25-7-4	1.4410	UNS S32750
Duplex Steel F51 (318 LN)	X2CrNiMoN22-5-3	1.4462	UNS S31803
Duplex Steel 310Mo LN	X2CrNiMoN2522	1.4466	UNS S31050
Steels for pressure vessels			
Vessel Steel A 204	16Mo3	1.5415	
Vessel Steel F12	13CrMo4-5	1.7335	
Vessel Steel F5	12CrMo19-5	1.7362	
Vessel Steel F22	10CrMo9-10	1.7380	
Nickel based alloys			
Nickel 201	Lc-Ni 99	2.4068	UNS N02201
Monel 400	NiCu 30 Fe	2.4360	UNS N04400
Hastelloy B-3	NiMo29Cr	2.4600	UNS N10675
Hastelloy B-4	NiMo29Cr	2.4600	UNS N10629
Hastelloy C-22	NiCr21Mo14W	2.4602	UNS N06022
Hastelloy C-59	NiCr23Mo16Al	2.4605	UNS N06059
Hastelloy C-4	NiMo16Cr16Ti	2.4610	UNS N06455
Hastelloy B-2 **	NiMo28	2.4617	UNS N10665
Inconel 600	NiCr 15 Fe	2.4816	UNS N06600
Hastelloy C-276	NiMo16Cr15W	2.4819	UNS N10276
Inconel 625	NiCr22Mo9Nb	2.4856	UNS N06625
Incoloy 825	NiCr21Mo	2.4858	UNS N08825
Titanium Based Alloys			
Titanium Gr.1	Ti 99,8	3.7025	UNS S32760
Titanium Gr.2	Ti 99,7	3.7035	UNS S32750
Others			
Silver Ag 0	Ag 99.97	n.a	
Zirconium Zr 702	Zr 99.20	n.a	UNS R60702

* hardness HV

** replaced by alloy B-3

*** approved for cryogenic application



SPETECH SUCCESSFUL SEALING SYSTEMS











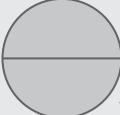

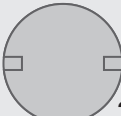
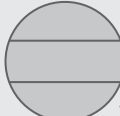

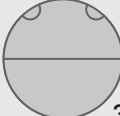

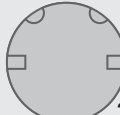

	Hardness HB	Tensile Strength	Yeld strength	Working temp °C		density
		N/mm ²	N/mm ²	from	to	g/cm ³
	100-130	340-470	215	-40	450	7,85
	130-180	410-530	215	-60	480	7,85
	130-180	470-610	315	-110	400	7,85
	max 90	170-350	190	60	450	7,85
	130-190	520-720	210	-200	550	7,9
	130-190	520-670	220	-200	550	8,0
	130-190	520-670	220	-200	550	8,0
	130-190	520-670	220	-200	550	8,0
	130-190	520-610	220	-200	550	8,0
	130-190	520-670	220	-60	400	7,9
	130-190	500-700	200	-270	550	7,9
	130-190	500-700	200	-200	550	7,9
	130-190	520-670	220	-270	550	8,0
	130-220	500-750	230	-110	800	7,9
	130-220	500-750	210	-110	1100	8,0
		730-930	530	-50	300	7,8
		730-930	530	-50	300	7,8
		650-880	448	-50	300	7,9
		540	260	-50	300	7,9
	140-170	440-590	260	-20	530	7,9
	150-180	440-590	275	-60	560	7,9
	170-220	590-740	390	-40	650	7,9
	130-180	470-620	270	-40	590	7,9
	80-150	380-450	160	-60	1100	8,9
	100-160	450-580	200	-200	500	8,9
	228	860	425	***	820	9,2
		760	350	***	820	9,2
		800	407	***	7760	8,6
		690	340	***	450	8,6
	155	800	421	***	760	8,6
						9,2
	140-200	550-800	200	-180	900	8,4
		790	415	-200	750	8,9
		880	460	-160	900	8,4
		690	310	-160	650	8,1
	110-160	290-410	180	-60	300	4,5
	120-180	390-540	250	-60	350	4,5
	25-45*	150-250	25	-270	750	10,5
	150*	379	209		350	6,5

Please note above data are approximate. Real values may vary depending from raw material source/ material treatment/ batch of material etc. Final values might be delivered after testing any of above materials in Spetech Sealing Material Testing Centre.

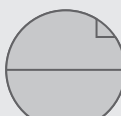

COMMON BARS SHAPES

Gaskets for apparatus are frequently requested with bars (called also ribs, partitions, etc.). Spetech may supply practically all its seals styles (kammprofiles, spiral-wounds, double jacketed, etc.) equipped with different shape of bars. To facilitate communication with Spetech representatives please use below codes to express necessary bars sections.

Product group	Types
A	 1
C	 1  2
D	 1  2
E	 1  2  3  4
F	 1  2  3
G	 1  2  3  4  5  6  7  8  9

COMMON BARS SHAPES

Product group	Types
H	
I	
J	
K	
L	
M	



GASKET PARAMETERS



	Designation	ASME s.VIII		AD-M B 7		DT-UC-90/WO-O/19		Value of 'b' factor for gaskets at temperature				
		y psi	m	k _{okD} N/mm	k ₁ mm	σ _m MPa	σ _r MPa	20°C	100°C	200°C	300°C	400°C
SPETOBAR®	BAS® 340	4400	2,00	20,0b _D	2,0b _D	26,5	4,0 p ₀	1,0	1,4	1,8	-	-
	BAS® 341	5100	2,85	25,0b _D	2,2b _D	35,7	5,7 p ₀	1,0	1,4	1,8	-	-
	BAS® 340 I	5100	2,50	25,0b _D	2,2b _D	35,7	5,0 p ₀	1,0	1,4	1,8	-	-
	BAS® 340 I	5800	2,90	30,0b _D	2,2b _D	40,8	5,8 p ₀	1,0	1,4	1,8	-	-
	BAS® 300	3600	2,00	18,0b _D	1,4b _D	25,5	4,0 p ₀	1,0	1,4	1,8	-	-
	BAS® 370	3600	2,00	18,0b _D	1,4b _D	25,5	4,0 p ₀	1,0	1,4	1,8	-	-
	BAS® 380	2900	2,00	15,0b _D	1,4b _D	20,4	4,0 p ₀	1,0	1,4	1,8	-	-
	BAS® 390	2900	2,00	15,0b _D	1,4b _D	20,4	4,0 p ₀	1,0	1,4	1,8	-	-
SPETOFLON® TEX	TEX FGR	2800	2,50	24,5b _D	2,5b _D	19,7	5,0 p ₀	1,1	1,8	2,6	-	-
	TEX FGR-R	2800	2,50	24,5b _D	2,5b _D	19,7	5,0 p ₀	1,1	1,8	2,6	-	-
	TEX FGR-H	2800	2,50	24,5b _D	2,5b _D	19,7	5,0 p ₀	1,1	1,8	2,6	-	-
	TEX FGR-F	2100	2,50	18,0b _D	2,0b _D	13,5	5,0 p ₀	1,1	1,8	2,6	-	-
	TEX FGR-J	2100	2,50	18,0b _D	2,0b _D	13,5	5,0 p ₀	1,1	1,8	2,6	-	-
	TEX DF	2500	1,50	22,0b _D	1,6b _D	18,3	3,0 p ₀	1,1	1,8	2,6	-	-
	TEX DE	2600	1,50	19,5b _D	1,6b _D	17,5	3,0 p ₀	1,1	1,8	2,6	-	-
	TEX DR	5000	3,75	30,0b _D	3,0b _D	35,5	7,5 p ₀	1,1	1,8	2,6	-	-
	TEX BG	2800	2,50	24,5b _D	2,5b _D	19,7	5,0 p ₀	1,1	1,8	2,6	-	-
GORE™	GORE™ 300 & 500 series	2800	2,50	24,5b _D	2,5b _D	19,7	5,0 p ₀	1,1	1,8	2,6	-	-
	GORE™ 600 series	2800	2,50	24,5b _D	2,5b _D	19,7	5,0 p ₀	1,1	1,8	2,6	-	-
SPETOFLON® FL	FL 100	3800	2,75	25,0b _D	1,5b _D	26,5	5,5 p ₀	1,1	1,8	2,6	-	-
	FL 160	3800	2,75	25,0b _D	1,5b _D	26,5	5,5 p ₀	1,1	1,8	2,6	-	-
	FL 200	3800	2,75	25,0b _D	1,5b _D	26,5	5,5 p ₀	1,1	1,8	2,6	-	-
	FL 300	4000	2,50	27,0b _D	1,3b _D	30,0	5,0 p ₀	1,1	1,8	2,6	-	-
	FL 160, FL 200 J, FL 300 J	2700	2,50	18,0b _D	1,3b _D	20,0	5,0 p ₀	1,1	1,8	2,6	-	-
	FL – TF	3000	2,50	25,0b _D	1,1b _D	21,0	5,0 p ₀	1,1	1,6	1,8	-	-

GASKET PARAMETERS

	Designation	ASME s.VIII		AD-M B 7		DT-UC-90/WO-O/19						
		y psi	m	$k_D k_D$ N/mm	k_1 mm	σ_m MPa	σ_r MPa	Value of 'b' factor for gaskets at temperature				
								20°C	100°C	200°C	300°C	400°C
SPETOFLON® FU, FY	FU BAS® 300 (FY BAS® 300)	3900	2,00	25,0b _D	1,1b _D	27,4	4,0 p ₀	1,1	1,8	2,6	–	–
	FU BAS® 300 J (FY BAS® 300 J)	3900	1,80	25,0b _D	1,1b _D	27,4	3,6 p ₀	1,1	1,8	2,6	–	–
	FU BAS® 340 (FY BAS® 340)	3900	2,07	25,0b _D	1,1b _D	27,4	4,1 p ₀	1,1	1,8	2,6	–	–
	FU BAS® 340 J (FY BAS® 340 J)	3900	1,80	25,0b _D	1,1b _D	27,4	3,6 p ₀	1,1	1,8	2,6	–	–
	FU GUS® 10 (FY BAS® 10)	3900	2,00	25,0b _D	1,1b _D	27,4	4,0 p ₀	1,1	1,8	2,6	–	–
	FU GUS® 20 (FY BAS® 20)	3900	2,00	25,0b _D	1,1b _D	27,4	4,0 p ₀	1,1	1,8	2,6	–	–
	FU GUS® 40 (FY BAS® 40)	3900	2,00	25,0b _D	1,1b _D	27,4	4,0 p ₀	1,1	1,8	2,6	–	–
	FU GUS® 10 J, FU GUS® 20 J, FU GUS® 40 J,	3900	1,50	25,0b _D	1,1b _D	27,4	3,0 p ₀	1,1	1,8	2,6	–	–
	FU MWK® 50	3100	2,75	20,0b _D	1,2b _D	21,4	5,5 p ₀	1,0	1,1	1,1	–	–
	FU MPL® 12	2100	2,50	18,0b _D	2,0b _D	13,5	5,0 p ₀	1,1	1,8	2,6	–	–
	F BAS® 301	4400	2,00	25,0b _D	1,3b _D	30,1	4,0 p ₀	1,1	1,8	2,6	–	–
	F BAS® 341	4400	2,10	25,0b _D	1,5b _D	30,6	4,1 p ₀	1,1	1,8	2,6	–	–
	F BAS® 381	4400	2,00	25,0b _D	1,3b _D	30,1	4,0 p ₀	1,1	1,8	2,6	–	–
	F GUS® 21	4400	2,00	25,0b _D	1,3b _D	30,1	4,0 p ₀	1,1	1,8	2,6	–	–
	F GUS® 41	4400	2,00	25,0b _D	1,3b _D	30,1	4,0 p ₀	1,1	1,8	2,6	–	–

GASKET PARAMETERS



	Designation	ASME s.VIII		AD-M B 7		DT-UC-90/WO-O/19						
		y psi	m	$k_0 k_D$ N/ mm	k_1 mm	σ_m MPa	σ_r MPa	Value of 'b' factor for gaskets at temperature				
								20°C	100°C	200°C	300°C	400°C
SPETOGRAF®	GUS® 10	2600	2,00	10,0b _D	2,0b _D	18,3	4,0 p ₀	1,0	1,1	1,1	1,1	1,2
	GUS® 10 I, GUS® 10 IZ	4400	2,00	15,0b _D	2,0b _D	30,9	4,0 p ₀	1,0	1,1	1,1	1,1	1,2
	GUS® 20	2500	2,52	7,0b _D	2,0b _D	17,5	5,0 p ₀	1,0	1,1	1,1	1,1	1,2
	GUS® 30 ¹	2600	2,54	16,0b _D	2,2b _D	18,3	5,1 p ₀	1,0	1,1	1,1	1,1	1,2
	GUS® 31 ¹ , GUS® 32 ¹ , GUS® 32 Z ¹ , GUS® 33 ¹	2600	2,08	15,0b _D	2,0b _D	18,3	4,2 p ₀	1,0	1,1	1,1	1,1	1,2
	GUS® 30 I ¹ , GUS® 30 IZ ¹	4400	2,00	30,0b _D	2,2b _D	20,4	4,0 p ₀	1,0	1,1	1,1	1,1	1,2
	GUS® 31 I ¹ , GUS® 31 IZ ¹ , GUS® 31 J ¹	2200	3,51	20,0b _D	2,2b _D	15,3	5,5 p ₀	1,0	1,1	1,1	1,1	1,2
	GUS® 40	2900	2,00	30,0b _D	1,5b _D	20,4	4,0 p ₀	1,0	1,1	1,1	1,1	1,2
	GUS® 41, GUS® 42, GUS® 43	2300	1,78	15,0b _D	2,0b _D	16,2	3,6 p ₀	1,0	1,1	1,1	1,1	1,2
	GUS® 41 I, GUS® 41 IZ	2900	2,00	30,0b _D	1,5b _D	20,4	4,0 p ₀	1,0	1,1	1,1	1,1	1,2
	GUS® 50	3000	4,78	30,0b _D	2,5b _D	21,1	4,0 p ₀	1,0	1,1	1,1	1,1	1,2
	GUS® 660 ² , GUS® 660 Z ¹ , GUS® 666 ¹ , GUS® 666 Z ¹	3000	1,50	30,0b _D	1,2b _D	20,0	3,0 p ₀	1,0	1,1	1,1	1,1	1,2
	GUS® 670 ¹ , GUS® 670 I ¹ , GUS® 670 IZ ¹ , GUS® 680 ¹	4400	2,90	45,0b _D	2,2b _D	30,9	5,8 p ₀	1,0	1,1	1,1	1,1	1,2
	GUS® 910, GUS® 920, GUS® 920 I, GUS® 922	7300	3,20	30,0b _D	1,6b _D	51,0	6,4 p ₀	1,0	1,1	1,1	1,1	1,2
GUS® 960, GUS® 960 I, GUS® 970, GUS® 970 I, GUS® 972	4400	2,90	45,0b _D	2,2b _D	30,9	5,8 p ₀	1,0	1,1	1,1	1,1	1,2	

¹ the same parameters should also be used with additional "W" designation, e.g. GUS® 31W

² for calculations, the width of the graphite layer instead of metal face should be used.

GASKET PARAMETERS

	Designation / materials		ASME s.VIII		AD-M B 7		DT-UC-90/WO-O/19							
			y psi	m	k ₀ k _D N / mm	k ₁ mm	σ _m MPa	σ _r MPa	Value of 'b' factor for gaskets at temperature					
									20°C	100°C	200°C	300°C	400°C	
SPETOMET® MWK®	MWK® 010 to MWK® 028 ²	depending on the sealing layer	graphite	2200	3,50	15,0b _D	1,1b _D	15,3	7,0 p ₀	1,0	1,1	1,1	1,1	1,1
		PTFE	2900	3,50	20,0b _D	1,1b _D	20,4	7,0 p ₀	1,0	1,1	1,1	-	-	
		aluminium	5500	3,50	50,0b _D	1,1b _D	38,8	7,0 p ₀	1,0	1,1	1,1	1,1	1,1	
		silver	10 200	3,50	100b _D	1,1b _D	71,4	7,0 p ₀	1,0	1,1	1,1	1,1	1,1	
	MWK® 050 to MWK® 065 ²	depending on the sealing layer	graphite	2400	2,75	15,0b _D	1,1b _D	16,5	5,5 p ₀	1,0	1,1	1,1	1,1	1,1
		PTFE	3100	3,50	20,0b _D	1,1b _D	21,4	5,5 p ₀	1,0	1,1	1,1	-	-	
		aluminium	5500	2,75	50,0b _D	1,1b _D	38,8	5,5 p ₀	1,0	1,1	1,1	1,1	1,1	
		silver	10 200	2,75	100b _D	1,1b _D	71,4	5,5 p ₀	1,0	1,1	1,1	1,1	1,1	
	DRYFLEX®	depending on the sealing layer	graphite	2200	2,50	15,0b _D	1,1b _D	15,3	5,0 p ₀	1,0	1,1	1,1	1,1	1,1
		PTFE	2900	3,00	20,0b _D	1,1b _D	20,4	5,5 p ₀	1,0	1,1	1,1	-	-	
		aluminium	5500	2,75	50,0b _D	1,1b _D	38,8	5,5 p ₀	1,0	1,1	1,1	1,1	1,1	
		silver	10 200	2,75	100b _D	1,1b _D	71,4	5,5 p ₀	1,0	1,1	1,1	1,1	1,1	
SPETOSPIR®	S, SW, SZ, SWZ	depending on the filler	graphite	4700	1,94	45,0b _D	1,3b _D	33,1	3,9 p ₀	1,0	1,1	1,1	1,1	1,1
		PTFE	5100	2,50	50,0b _D	1,3b _D	35,7	5,0 p ₀	1,0	1,1	1,1	-	-	
SPETOMET® MPL®	MPL® 10	depending on the sealing layer	graphite	2600	6,00	15,0b _D	1,2b _D	18,7	12,0 p ₀	1,0	1,1	1,1	1,1	1,1
		PTFE	3900	6,00	20,0b _D	1,2b _D	27,4	2,0 p ₀	1,0	1,1	1,1	1,1	1,1	
	MPL® 11	parameters are included in the tables of relevant standard												
	MPL® 12	graphite, PTFE	2600	2,00	15,0b _D	1,0b _D	18,8	4,0 p ₀	1,0	1,1	1,1	1,1	1,1	1,2
	MPL® 121	depending on the sealing layer	graphite	2100	2,00	10,0b _D	1,0b _D	14,3	4,0 p ₀	1,0	1,1	1,1	1,1	1,2
		PTFE	2100	2,50	18,0b _D	2,0b _D	13,5	5,0 p ₀	1,1	1,8	2,6	-	-	
	MPL® 20, MPL® 21, MPL® 23, MPL® 24, MPL® 23 1, MPL® 30, MPL® 31	depending on the jacket	aluminium	4400	2,80	40,0b _D	1,6b _D	31,0	5,6 p ₀	1,0	1,1	1,1	1,1	1,2
		copper, brass	5200	2,80	50,0b _D	1,6b _D	36,5	5,6 p ₀	1,0	1,1	1,1	1,1	1,2	
		iron, soft iron	6100	3,00	60,0b _D	1,6b _D	42,7	6,0 p ₀	1,0	1,1	1,1	1,1	1,2	
		stainless steel	8100	3,20	80,0b _D	1,6b _D	57,1	6,4 p ₀	1,0	1,1	1,1	1,1	1,2	
MPL® 26, MPL® 29	depending on the jacket	aluminium	4400	2,80	40,0b _D	1,6b _D	31,0	5,6 p ₀	1,0	1,1	1,1	1,1	1,2	
	copper, brass	5200	2,80	50,0b _D	1,6b _D	36,5	5,6 p ₀	1,0	1,1	1,1	1,1	1,2		
	iron, soft iron	6100	3,00	60,0b _D	1,6b _D	42,7	6,0 p ₀	1,0	1,1	1,1	1,1	1,2		
	stainless steel	8100	3,20	80,0b _D	1,6b _D	57,1	6,4 p ₀	1,0	1,1	1,1	1,1	1,2		

¹ width of the sealing area of the metal gaskets without soft sealing layers depends on the number of grooves

² width of the sealing area of the metal gaskets with PTFE or graphite sealing layers should be calculated with regards to their gasket's width not the number of grooves

³ SPETOSPIR® Standard gaskets always have graphite as the filler



GENERAL INFORMATIONS

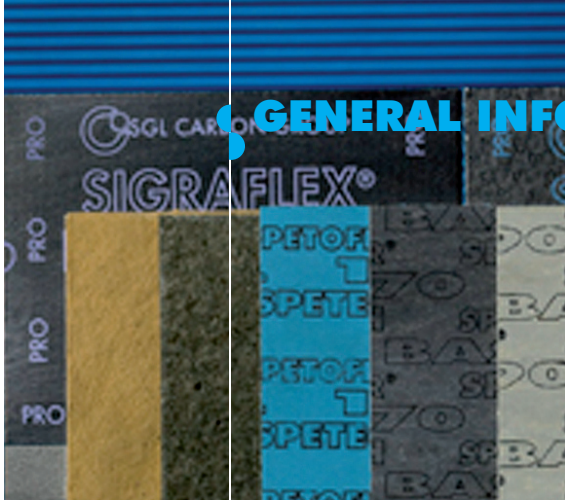

© Fluid Sealing Association
European Sealing Association



ESA Installations Procedures

<p>Tools Required</p>		<p>Specific tools are required for cleaning and tensioning the fasteners. Additionally, always use standard safety equipment and follow good safety practices. Acquire the following equipment prior to installation:</p> <ul style="list-style-type: none"> – Calibrated torque wrench, hydraulic or other tensioner – Wire brush (brass if possible) – Helmet – Safety goggles – Lubricant – Other plants – specified equipment
<p>Clean and examine</p>		<ul style="list-style-type: none"> • Remove all foreign material and debris from the seating surfaces, fasteners (bolts or studs), nuts, and washers. Use plant-specified dust control procedures. • Examine fasteners (bolts or studs), nuts, and washers for defects such as burrs or cracks. • Examine flange surfaces for warping, radial scores, heavy tool marks, or anything prohibiting proper gasket seating. • Replace components if found to be defective. If in doubt, seek advice.
<p>Align flanges</p>		<ul style="list-style-type: none"> • Align flange faces and bolt holes without using excessive force. • Report any misalignment.
<p>Install packing</p>		<ul style="list-style-type: none"> • Assure gasket is the specified size and material. • Examine the gasket to ensure it is free of defects. • Carefully insert gasket between flanges. • Make sure the gasket is centered between the flanges. • Do not use jointing compounds or release agents on the gasket or seating surfaces unless specified by the gasket manufacturer. • Bring flanges together, ensuring the gasket isn't pinched or damaged.



ESA Installations Procedures

Lubricate load-bearing surfaces



- Use only specified or approved lubricants.
- Liberally apply lubricant uniformly to all thread, nut, and washer load-bearing surfaces.
- Ensure lubricant doesn't contaminate either flange or gasket face.

Install and tighten bolts



- Always use proper tools: calibrated torque wrench or other controlled tensioning device.
- Consult your gasket manufacturer and/or engineering department for guidance on torque specifications.
- Always torque nuts in a cross bolt tightening pattern.
- Tighten the nuts in multiple steps:
 - Step 1 – Tighten all nuts initially by hand. (Larger bolts may require a small hand wrench.)
 - Step 2 – Torque each nut to approximately 30% of full torque.
 - Step 3 – Torque the nuts to approximately 60% of full torque.
 - Step 4 – Torque each nut to full torque, again using the cross bolt tightening pattern. (Large-diameter flanges may require additional tightening passes.)
 - Step 5 – Apply at least one final full torque to all nuts in a clockwise direction until all torque is uniform. (Large-diameter flanges may require additional tightening passes.)

Retightening



Caution: Consult your gasket manufacturer and/or engineering department for guidance and recommendations on retightening.
Do not retorque elastomer-based, asbestos-free gaskets after they have been exposed to elevated temperatures unless otherwise specified.
Retorque fasteners exposed to aggressive thermal cycling.
All retorquing should be performed at ambient temperature and atmospheric pressure.



SPETECH SUCCESSFUL SEALING SYSTEMS





SPETECH®, DryFlex®, SPETORING®, SPETOGAF®, SPETOFLON®, SPETOMET®, SPETOSPİR®, SPETOTERM®, GRAFMET®, SPETOPAK®, TRANSFLEX®, MWK® are registered trademarks of SPETECH. Gore-GFO®, Gore® – registered trademarks of W.L.Gore. Sigraflex® – registered trademark of SGL Carbon Group. Data presented above is based on the best available knowledge but does not imply liability on Spetech's part. The proper service of the installation depends on many factors which need to be evaluated on case to case basis. SPETECH® reserves the right to update and introduce changes in accordance with the best knowledge and technology available in the area described in this catalogue.



SPETECH SUCCESSFUL SEALING SYSTEMS

80

ООО «ТИ-СИСТЕМС» ИНЖИНИРИНГ И ПОСТАВКА ТЕХНОЛОГИЧЕСКОГО ОБОРУДОВАНИЯ
Интернет: www.tisys.ru www.tisys.kz www.tisys.by www.tesec.ru www.ти-системс.рф
Телефоны: +7 (495) 7774788, 7489626, (925) 5007155, 54, 65 Эл. почта: info@tisys.ru info@tisys.kz info@tisys.by